



Project no.

SSPE-CT-2004-502173

Project title

**EMF-NET: EFFECTS OF THE EXPOSURE TO ELECTROMAGNETIC
FIELDS: FROM SCIENCE TO PUBLIC HEALTH AND SAFER WORKPLACE**

Instrument:

Co-ordination action

Thematic Priority:

Priority 8, POLICY ORIENTED RESEARCH – AREA 2.3, Call Identifier FP6-2002-SSP-1

Deliverable D49 - Fact Sheet
EMF-NET Main Task MT2 WORKEN

Due date of deliverable: March 2008, Actual submission date: April 2008

Start date of project: March 2004 Duration: 54 months

Organisation name of lead contractors for these deliverables:
CIOP-PIB (MT2 coordinator), FIOH, ISPESL, NIWL, VITO

CONTENT

Practical guidance on occupational EMF exposure assessment

Occupational exposure fact sheet: Microwave dryers

Occupational exposure fact sheet: Mobile phone base station

Occupational exposure fact sheet: RF wood glue drying

Occupational exposure fact sheet: RF plastic welding machines

Occupational exposure fact sheet: Assessment of occupational exposure to intermediate frequency electromagnetic fields in practice

Occupational exposure fact sheet: ELECTROSURGERY. Occupational exposure to electromagnetic fields - assessment in practice

Occupational exposure fact sheet: Hand held Magnetic Reactivator

Occupational EMF Exposure Database

Practical Guidance for Occupational Low Frequency Exposure Assessment

Occupational exposure fact sheet Hand held Magnetic Reactivator

Practical guidance for occupational EMF exposure assessment Numerical dosimetry

Practical guidance on occupational EMF exposure assessment

radiofrequency range (100 kHz–300 GHz)

What are Electromagnetic fields, EMFs?

Electromagnetic fields (EMF) are present everywhere in our environment but are invisible to the human eye. EMF is described in terms of electric and magnetic fields. Electric fields are created by differences in voltage: the higher the voltage, the stronger will be the resultant field. Magnetic fields are created when electric current flows: the greater the current, the stronger the magnetic field. An electric field will exist even when there is no current flowing. If current does flow, the strength of the magnetic field will vary with power consumption but the electric field strength will be constant. The strength of the electric field is measured in volts per meter (V/m). The strength of the magnetic field is measured in amperes per meter (A/m); more commonly in EMF research, scientists specify a related quantity, the flux density (in microtesla, μT) instead.

Electric fields are produced by the local build-up of electric charges in the atmosphere associated with thunderstorms. The earth's magnetic field causes a compass needle to orient in a North-South direction and is used by birds and fish for navigation. Besides natural sources the electromagnetic spectrum also includes fields generated by human-made sources: The electricity that comes out of every power socket has associated low frequency electromagnetic fields. And various kinds of higher frequency waves are used to transmit information – whether via TV antennas, radio stations or mobile phone base stations. Mobile telephones, television and radio transmitters and radar produce radio frequency (RF) fields. Microwaves are RF fields at high frequencies in the GHz range.

At radio frequencies, the electric and magnetic fields are closely interrelated and we typically measure their levels as power densities in watts per square meter (W/m^2).



What makes the various forms of electromagnetic fields so different?

One of the main characteristics which define an electromagnetic field is its frequency or its corresponding wavelength. Fields of different frequencies interact with the body in different ways. One can imagine electromagnetic waves as series of very regular waves that travel at an enormous speed, the speed of light. The frequency simply describes the number of oscillations or cycles per second, while the term wavelength describes the distance between one wave and the next. Hence wavelength and frequency are inseparably intertwined: the higher the frequency the shorter the wavelength.

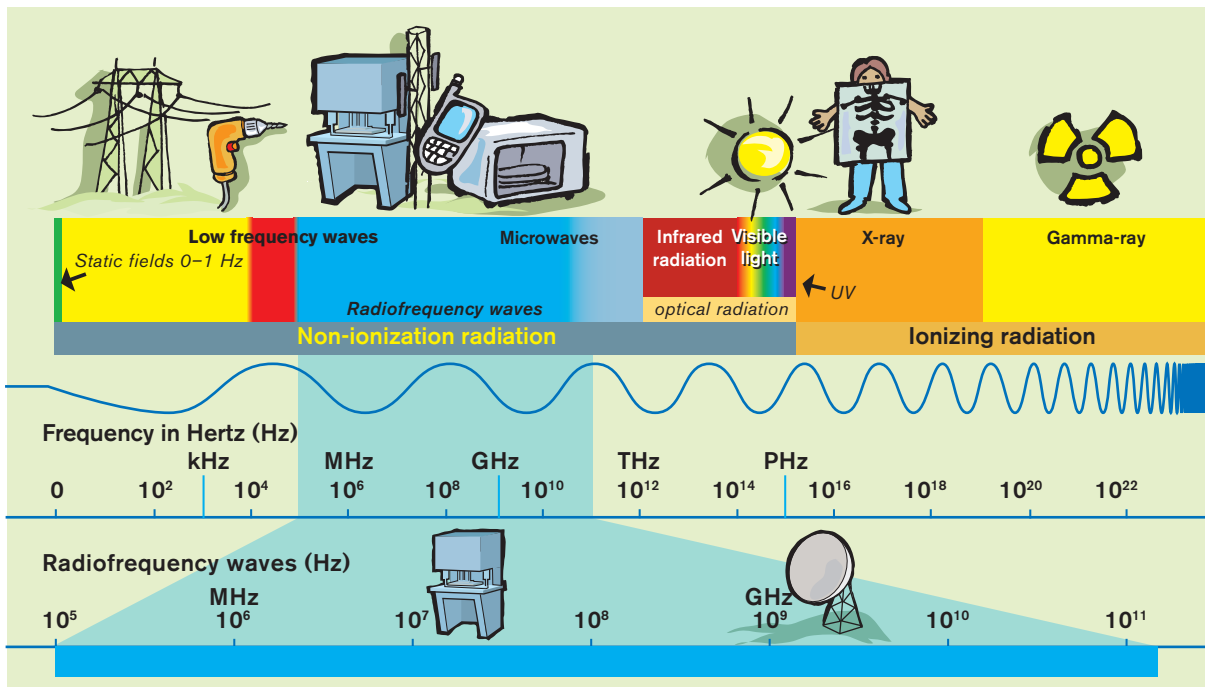

The electromagnetic spectrum. This brochure deals with the radiofrequency range, 100 kHz to 300 GHz.

What is the difference between non-ionising electromagnetic fields and ionising radiation?

Wavelength and frequency determine another important characteristic of electromagnetic fields: Electromagnetic waves are carried by particles called quanta. Quanta of higher frequency (shorter wavelength) waves carry more energy than lower frequency (longer wavelength) fields. Some electromagnetic carry so much energy per quantum that they have the ability to break bonds between molecules. In the electromagnetic spectrum, gamma rays given off by radioactive materials, cosmic rays and X-rays carry this property and are called 'ionising radiation'. Fields whose quanta are insufficient to break molecular bonds are called 'non-ionising radiation'.

What are the effects of RF fields?

Radiofrequency waves are used either for energy absorption depending on electrical properties of the material or are used for different kinds of wireless communication or signal transfer.

Occupational exposure to RF fields has increased during the last decades due to more technical application of new techniques and mainly the use of RF for communication.

Within the RF frequency range different established adverse effect can be expected if the RF field intensity is high enough. Induced current in head and trunk have effects on the

central nervous system in the range up to 10 MHz. Furthermore from 100 kHz and up to 10 GHz energy absorption and thereby tissue heating can occur. From 10 GHz and up to 300 GHz there is a risk for tissue heating at or near the body surface.

Regulations (ICNIRP, EU-directive)

In 2004 the European Parliament agreed on a directive concerning minimum health and safety requirements regarding workers risks arising from exposure to electromagnetic fields (Directive 2004/40/EC). This directive, which is the 18th individual directive within the meaning of Article 16(1) of directive 89/391/EEC, lays down minimum requirements for the protection of workers from risks to their health and safety arising or likely to arise from exposure to electromagnetic fields during their work.

The directive includes fields with frequencies from 0 Hz to 300 GHz and is based on the document on risk evaluation produced by the International Commission on Non-Ionizing Radiation Protection, ICNIRP (ICNIRP, 1998). The EU directive should be implemented in all countries in EU latest April 2012.

The occupational exposure limit values in the EU directive, are based on established biological effects and biological considerations. In the RF range the directive is set to protect workers against acute established effects as harmful tissue heating and induced current. Specific energy Absorption

Rate (SAR) in the whole body or part of the body is a widely accepted measure for thermal effects in the RF range. It is expressed in the unit watts per kilogram (W/kg). Another measure in the RF range is the current density (j) defined as the current flowing through the body or part of it and expressed in amperes per square meter (A/m²). In the frequency range above 10 GHz where the depth of the penetration of the field into the body is very low, power density is the appropriate quantity and expressed in watts per square meter (W/m²).

In most situations it is not possible to measure the limit values but the directive also contains action values which give the magnitude of direct physical measurable parameters.

Depending in what part of the RF frequency range the exposure occurs, from three to six different parameters need to be measured to ensure compliance with the directive.

If the limits given by the values for all parameters in the actual frequency range are below the stated action value, the basic restrictions are fulfilled. If any of the action values are exceeded, the basic restrictions can still be accomplished. In this case numerical calculations are needed to show compliance with the exposure limits of the directive.

The following physical quantities can be measured directly and are used to describe the exposure to electromagnetic fields in the RF range (Directive 2004/40/EC):

Contact current (IC) between a person and an object is expressed in amperes (A). A conductive object in an electric field can be charged by the field.

Electric field strength is a vector quantity (E) that corresponds to the force exerted on a charged particle regardless of its motion in space. It is expressed in volts per metre (V/m).

Magnetic field strength is a vector quantity (H), which, together with the magnetic flux density, specifies a magnetic field at any point in space. It is expressed in amperes per metre (A/m).

Magnetic flux density is a vector quantity (B), resulting in a force that acts on moving charges, expressed in teslas (T). In free space and in biological materials, magnetic flux density and magnetic field strength can be interchanged using the equivalence $1 \text{ A/m} = 4\pi \cdot 10^{-7} \text{ T}$.

Power density (S) is the appropriate quantity used for very high frequencies, where the depth of penetration in the body is low. It is the radiant power incident perpendicular to a surface, divided by the area of the surface and is expressed in watts per square metre (W/m²).

Table 1. The exposure limit values in the RF range (100 kHz – 300 GHz).

Frequency range	Current density for head and trunk j (mA/m ²) (rms)	Whole body average SAR (W/kg)	Localised SAR (head and trunk) (W/kg)	Localised SAR (limbs) (W/kg)	Power density S (W/m ²)
100 kHz–10 MHz	$f/100$	0.4	10	20	–
10 MHz–10 GHz	–	0.4	10	20	–
10–300 GHz	–	–	–	–	50

Table 2. Actions values (unperturbed rms values)

Frequency range	Electric Field strength, E (V/m)	Magnetic Field strength, H (A/m)	Magnetic flux density, B (μT)	Equivalent plane wave power density, S_{eq} (W/m ²)	Contact current, I_c (mA)	Limb induced current, I_L (mA)
0.1–1 MHz	610	1.6/ f	2/ f	–	40	–
1–10 MHz	610/ f	1.6/ f	2/ f	–	40	–
10–110 MHz	61	0.16	0.2	10	40	100
110–400 MHz	61	0.16	0.2	10	–	–
400–2000 MHz	$3f^{1/2}$	$0.008f^{1/2}$	$0.01f^{1/2}$	$f/40$	–	–
2–300 GHz	137	0.36	0.45	50	–	–

Occupations exposed to RF

The use of RF fields in our workplaces has increased rapidly during the last decade, mainly due to the increased use of wireless communication technique, security devices and in medical applications. However, workers exposure in these cases is in general low and not in conflict with the EU directive, but there are exceptions.

In office as well as in industry and transportation environment wireless communications are frequently used. The indoor base stations as well as different blue tooth equipment and WLAN used for man to machine or machine to machine communication have a low output power and therefore the possible exposure of workers is not in conflict with the regulations.

Low exposure can also be expected when the sources are enclosed. Examples in the industry are plasma metallization and polymerization, plasma deposition and etching and microwave heating, for instance vulcanization of rubber. These processes are normally performed in closed chambers, but there might be leakages especially after reconstructions or changes in process and therefore a simple recurrent check might be a part of the assessment.

The number of devices used for security purpose, as anti-theft and personal access control have increased rapidly in shops, libraries, airports and restricted areas. These devices work at

different frequencies depending on what technique is used. Several work below 100 kHz, but the RFID equipment (Radiofrequency Identification Device) works at 120-154 kHz and there are also devices working at 4.9 GHz. Electronic Article Surveillance (EAS) systems work usually in the MHz range both in continuous swept frequency and at fixed pulsed frequency at the detector. Normally, the staff is only passing through and therefore are only exposed during a short period and not in conflict with the regulations. However, there might be devices situated near a permanent working place, for instance a cashier and in that case actions must be taken to insure that the regulations are fulfilled.

RF exposure that need special attention

In some workplaces it will be necessary to take measurement for showing compliance with the EU directive. Examples of such workplaces are given below:

Dielectric heaters

RF sealers and glue dryers are two examples of dielectric heaters frequently used in the industry to seal plastic objects and to glue wood details.

In workplaces where these devices are used it is necessary to perform detailed measurements of both electric and magnetic fields as well as contact and induced currents. These measurements often need to be done on a regular basis, perhaps yearly, since the radiation pattern from the machinery is changing with use. See further the separate fact sheets on dielectric heating.

Induction heating

Induction heaters are usually operating at frequency ranges from a few Hz up to 10 MHz. In some processes the operator get near the device for visual control of the object and might therefore be highly exposed. See separate fact sheet.

Industrial microwave ovens and microwave drying

Often these ovens are closed and no access is given to areas where high intensity microwave can be encountered. However, there may be leakage in some cabinets and connections, and a regular maintenance program is recommended.

Microwaves are also used for drying of water damage in buildings. These applications are usually high powered devices and with an applicator that has some potential leakage. Due to the high intensity microwave energy used it is also possible to get exposure on the other side of the wall or floor where the applicator is located.



Operating a machine like this the exposure to the head and hands are strong due to the closeness to unshielded electrode.

Great care in use of these devices is needed, and in some countries there is a demand for licensing for the use of these machines.

Radar

In general it would be exceptionally to find cases of staff being exposed to direct emissions of radar signals from the antennas. Often measurement is not needed and the exposure assessment can be done by numerical calculations. However, during manufacturing, service and repair it may happen that staff accidentally can be exposed.

Medical applications

Mainly there are three applications in medicine of interest in this context: Physiotherapeutic use of diathermy, Surgical diathermy and Magnetic resonance imaging (MRI).

In medical clinics RF are used in physiotherapy in shortwave or microwave diathermy treatment. In these cases the applicators are open, and possible overexposure of the staff can occur. Strict adherence to safety instructions is needed, but seldom is there a need to take new measurements.

In the operation theatre surgical diathermy is used. RF energy is used to cut and coagulate, and since unshielded electrodes are used the fields are rather intense and special attention is needed to ensure compliance with the directive on occupational exposure.

In the MRI, RF is one the electromagnetic components that are used. With normal MRI applications only inside the magnet bore is the RF field of intensity high enough to cause concern. This exposure is easily avoided by safety

instructions to the staff. See separate fact sheet on MRI. However, with use of interventional MRI the RF exposure might be of concern, and an exposure assessment is needed.

Broadcasting and other communications

Radio and TV broadcasting installations are usually safe work places. However, there is a potential for involuntary, accidental intense exposure of staff. In most the cases, technical staff working at radio/TV broadcasting equipments, are technically well informed and trained. However, when working near antennas with repair or adjustment during broadcasting occupational exposure is likely to be in conflict with the EU directive. These situations should be avoided.

Rooftop workers near base stations antennas might be exposed to RF fields about 900–2000 MHz. Examples of such workers are sheet-metal workers, chimney-sweeper and painter. In these cases the emission properties are well defined and simple instructions are more relevant than measurements. See separate fact sheet on base station exposure.

In case measurement of a mobile phone base station antenna site is needed there is a CENELEC document to be follow.

How to do the assessment of RF field exposure in the workplace

The responsibility for the assessment is on the employer, defined according to directive 89/391/EEC as any natural or legal person who has an employment relationship with the worker and has responsibility for the undertaking and/or establishment. In most cases the employer will delegate the practical part of the assessment to a safety engineer, occupational hygienist or technician familiar with the process and if needed to contact an EMF consultant for measurements or help with the interpretation of numerical calculations or what proper actions have to be taken.

A flow sheet for the assessment procedure is show below. The first step is to identify if there are any RF emitting sources at the workplace.

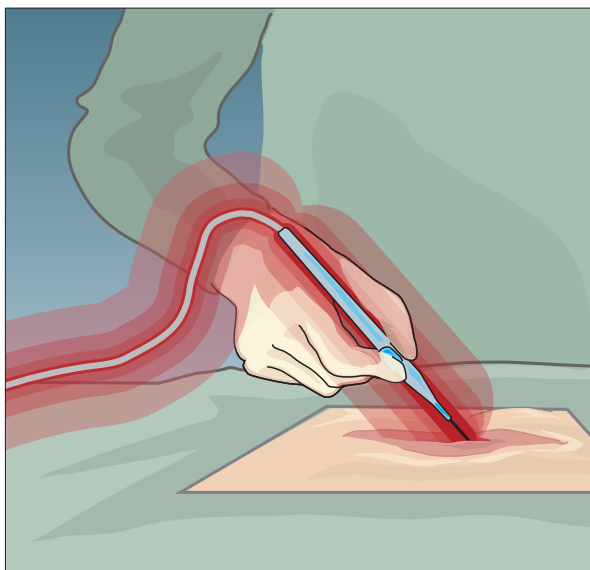

In surgical diathermy unshielded cables are used for the active electrode, and the patient is placed on the ground electrode. This gives rise to high intensity electric field around the cables and often the action levels in the EU directive are exceeded.

If there are no such equipment the assessment is finished. If on the other hand there are some RF emitting equipments and there are available document showing that the entire emission from these devices are not in conflict with the action values the EU directive is fulfilled. If however, there are no documents available, measurements must be performed according to the procedure stated in available standard documents or if no such document exist, according to best practice. It should be noted that sometimes the standard is only for emission measurement and not for exposure assessment. For instance, measurement according to standard are to be taken at a distance from the device but the user of the device makes

contact with it, then the exposure has to be assessed from this perspective.

If the action values are exceeded, actions must be taken to reduce the exposure. If the values still are above the action values and no more actions could be taken numerical calculations might be needed to ensure that the limit values are not exceeded. This is a very costly process and mainly reserved for trade organizations, for instance corporations of welding industry, MRI manufactures, mobile phone industry and so on. For more information about the numerical calculation see separate brochure.

Available exposure/emission standards.

Most standards for measurements are to be regarded as emission standards, i.e. they are useful in comparing different devices/appliances, but when it comes to exposure assessment other aspects need to be taken into account. As an example we can take the standard for how to measure handheld electrical machines or welding equipment. The standards are given measuring distances of 20 to 30 cm from the machine or cable, but the worker is having the cable and the machine in contact with the body. Another aspect is that the standard seldom applies to the worst case scenario – although it might be seldom used but for the exposure assessment this case is what we are looking for. It is therefore necessary to adopt another procedure in order to make a correct exposure assessment.

As a base for the assessment CENELEC has newly issued a draft to a European Standard EN 50499, Determination of workers exposure of electromagnetic fields. This document gives an overview of the assessment procedure in the frequency range from 0 Hz to 300 GHz and is based on and taken into account other document and available standards of interest for the assessment. Available document of interest for the RF exposure assessment are listed below.

Instrumentation needed

To make EMF measurement in the frequency range 100 kHz to 300 GHz one needs to have different sets of instruments for each of the frequency spans. Usually the instrumentation only covers a certain range of

Flow sheet for the assessment of RF exposure in the work places

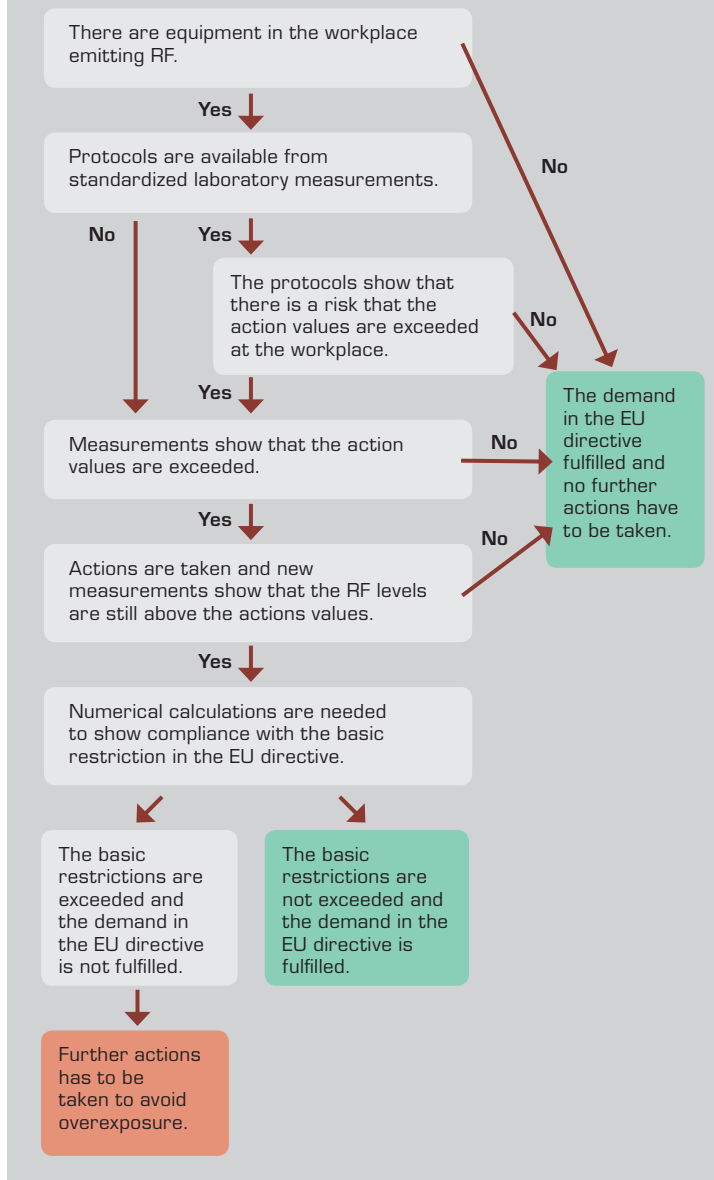

frequencies, for instance from 100 kHz to 30 MHz, another set goes from 10 MHz to 300 MHz and other from 100 MHz to 10 GHz, and then for the higher GHz another set is needed.

For frequencies below 300 MHz typically one needs to measure both the electric and magnetic fields. Usually commercial instruments are equipped with exchangeable probes for E and H fields. Below 100 MHz there is also a need to measure both the contact and the induced current, and this demands another set of instruments.

For most measurements in the lower part of this frequency range it is useful to have some way to measure the main frequency of the device under test, since the limit values are frequency dependent. However, some of the modern commercial instruments do have a weighted frequency response and give a percentage reading in relation to the limit values.

Preparation before measurement

The following questions are of importance to answer before the visit to the work place:

- Why are the measurements ordered
- Has RF been measured at the workplace earlier
- What type of sources are emitting RF
- Is there any information about the emitting equipment, model
- What are the operating frequencies
- What is the duty cycle, (worst case situation)
- What is the output power
- Are there any earlier protocols available

How to measure RF fields

When you have done the preparation as outlined above and are ready to start the measurements, always approach the source with caution until you know what to expect. In the simplest case you find that all values, E or H field, are below the action levels, then there is no need to go any further.

However, if some of the values are above the action values, the measurements have to be done more carefully and with a spatial averaging over the body. Select about 4–6 spots – head, chest, groin, thighs – and make the recordings. Note the measurements have to be done without the operator present since the fields are strongly distorted by the presence a person. The spatial

averaging have to be done on the E^2 or H^2 values, since the exposure limit is based on SAR which is directly proportional to the these values.

If the averaged value then is below the action level then the directive is fulfilled. If not the next step is time averaging. The SAR limit is time averaged over any 6 minute period, and the next step will be to see the timing of the exposure and how long duty cycle the process has. This should then be applied to the spatial average value to see how it then compares with the action levels.

If nothing of the above is sufficient to show compliance then we have numerical calculation, i.e. to see how the measured values give rise to current and SAR in the body. This should really be treated as a last resort, and long before this is applied, reduction measures should be undertaken.

To reduce the exposure to RF often a maintenance program is of help; make sure all covers are in place and with all screws tightly drawn; replace damage brass foils used for conducting the current and grounding; make sure the operator is not in contact with ground; keep the safety distance to the machine; is the settings of the machine optimal for field reduction.

Demands on the Report

The measurement report should state:

- Who ordered the measurement
- Who did the measurement and when
- Who were present from the company
- What instrument was used and when where these calibrated
- What measurement method was used, identification of the machine and site, serial number or equivalent
- What was the production during the measurement, i.e. worst case
- Values given as mean with the estimated uncertainty in the measurements
- Was there a need to measure induced and contact current, if not state why

The report should also have a clear statement as to whether the action levels are met or not, and what measures to reduce exposure can be taken. It should also give a statement if there is a need for numerical calculation to show compliance with the directive.

References

- Arpansa, 2003. *Radiation protection standard. Maximum exposure levels to radiofrequency fields –3 kHz to 300 GHz. Radiation protection Series no 3. Australian radiation protection and nuclear safety agency.*
- CENELEC 2004. *Generic standard to demonstrate the compliance of electronic and electrical apparatus with the basis restrictions related to human exposure to electromagnetic fields (0 Hz – 300 GHz) EN 50392.*
- CENELEC 2006. *Basic standard on measurement and calculation procedures for human exposure to electric and magnetic and electromagnetic fields (0 Hz – 300 GHz). Draft pr EN 50413.*
- CENELEC 2006. *Basic standard on measurement and calculation procedures for human exposure to electric and magnetic and electromagnetic fields (0 Hz – 300 GHz). Draft pr EN 50477.*
- CENELEC 2006. *Determination of workers exposure to electromagnetic fields. EN 50499.*
- Directive 2004/40/EC of the European Parliament and of the Council of 29 April 2004 on the minimum health and safety requirements regarding the exposure of workers to the risks arising from physical agents (electromagnetic fields) (18th individual Directive within the meaning of Article 16(1) of Directive 89/391/EEC), O.J. nr L-184 of 24 May 2004.*
- ICNIRP *Guidelines for Limiting Exposure to Time-Varying Electric, Magnetic, and Electromagnetic Fields (up to 300 GHz), Health Physics, vol. 74, No. 4 (April), 494-522, 1998.*
- ICNIRP *General approach to protection against non-ionizing radiation. Health Physics; 82; No. 540-548; 2002.*
- ICNIRP *Statement on Medical Magnetic Resonance (MR) Procedures: Protection of Patients. Health Physics 87(2): 197-216; 2004.*
- IEEE Std C95.1. *Standard for Safety Levels with Respect to Human Exposure to Radio Frequency Electromagnetic Fields, 3 kHz to 300 GHz. 2005 Edition Published by the Institute of Electrical and Electronics Engineers, New York, USA, 2006.*
- IEEE *recommended practice for Radio Frequency Safety Programs, 3 kHz to 300 GHz. Published 22 March 2006. IEEE Std C95.7-2005.*
- NCRP. *A practical guide to the determination of human exposure to radiofrequency fields. NCRP Report no 119. 1993.*
- NIOSH *Manual for measuring occupational electric and magnetic field exposure. U.S. Department of Health and Human Services. Public Health Service. Centres for Disease Control and Prevention. National Institute for Occupational Safety and Health. DHHS (NIOSH) Publication No. 98-154.*
- NIOSH/WHO *Occupational EMF document. Evaluation and managing occupational exposure to EMF. A Joint Publication of the World Health Organization International EMF Project and the U.S. Centres for Disease Control and Prevention, National Institute for Occupational Safety and Health. In preparation.*
- WHO Fact Sheet. *Medical response to radio frequency overexposure.*

An information publication from the EMF NET project

Authors: Kjell Hansson Mild, Dept. of Radiation Physics and Monica Sandström, Occupational and Environmental Medicine, Umeå University, Umeå, Sweden

Phone +46 (0)90 785 0000 • <http://web.jrc.ec.europa.eu/emf-net/>

Graphic design and illustrations: Guldbrand & Guldbrand

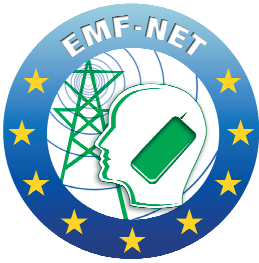

An information publication from the EMF NET project
SSPE-CT-2004-502173 EMF-NET MT2 working group
Effects of the Exposure to Electromagnetic Fields:
From Science to Public Health and Safer Workplace.
Coordination Action 8. Policy Support and Anticipating
Scientific and Technological Needs



Occupational exposure fact sheet

Microwave dryers

Microwaves at frequencies of 915 and 2 450 MHz are commonly used for drying of building components, such as ceilings and exterior wall surfaces, required in construction and repair work. In addition, it is very common to use microwave technology for drying of water damages in wet walls or water flooded floors after fires and other accidents.

Microwave energy from the magnetron is guided to structures in order to vaporise water from wet material. Thus, the principle is the same as applied for heating foodstuffs inside household microwave ovens. However, the power of the portable drying unit is higher, typically ranges from 1 to 5 kW.



A mobile microwave dryer contains a generator with horn antenna mounted inside of metallic housing. In typical operation an antenna is put against wet wall and set is turned on by push on control device. Microwave energy from the generator is emitted to the wall and heat the water uncovered inside of the wall capillary. In order to avoid stray radiation, the microwave applicators are directed downright towards the material to be heated.

Power densities of microwave radiation emitted by drying appliances are very high, being more than 100 kW/m^2 in front of the applicator, and about 10 kW/m^2 at a distance of 20 cm. In some cases, power density on the backside of the wall to be dried may still exceed 1 kW/m^2 , diminishing to 100 W/m^2 at a distance of about 2 m behind the wall.

In addition, stray fields from surrounding surfaces may exceed the occupational exposure

limit value (50 W/m^2) at a distance of 50 cm. Therefore, microwave drying units should be used only by authorized users who are aware of the potential health risks.

The present drying technology should apply remote control to ensure that cut-off occurs as soon as someone enters the danger area. Safety can be increased still further by room screening using aluminized films or composites of aluminium films and paper. The safety systems may consist of photocells, movement sensors, infrared radiation sensors etc. More conventional methods with uncomplicated electric contact switches are useable too. A locking system, that makes sure that only qualified operators having keys are able to restart the microwave dryers after cut-off, can ensure that unintended starting cannot endanger workers or other persons close-by.

An information publication from the EMF NET project

Author: Maila Hietanen, Finnish Institute of Occupational Health, Helsinki, Finland.

Phone +358 (0)30 4741 • <http://web.jrc.ec.europa.eu/emf-net/>

Photo: Martti Kainulainen, Lehtikuva.

Graphic design: Guldbbrand & Guldbbrand

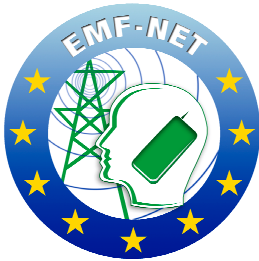

An information publication from the EMF NET project
SSPE-CT-2004-502173 EMF-NET MT2 working group
Effects of the Exposure to Electromagnetic Fields:
From Science to Public Health and Safer Workplace.
Coordination Action 8. Policy Support and Anticipating
Scientific and Technological Needs



Occupational exposure fact sheet

Mobile phone base station

Mobile telephony base stations

Mobile phones communicate by radiofrequency (RF) signals passing between the phone and base station antennas. Base station antennas are placed on masts, roof tops, building facades and inside buildings, and on other suitable places having good coverage area. Base station antennas usually send and receive radio transmissions, but some antennas operate as receive only antennas, thus having no transmissions.

Exposure to base station antennas

RF emissions vary depending on the design and power of base station. The transmission powers are relatively low, usually less than 40 W. Generally, most powerful antennas are sited on highest places, such as on broadcasting towers. On the other hand, base station antennas situated inside the buildings have lowest transmission powers, usually less than 1 W. These low power antennas can be considered to be safe from the point of occupational exposure at any distance. Occupational exposure is possible during maintenance of base station, as well as during construction and similar tasks on the roof in close proximity to the antenna. Antennas should be mounted so that general public can not get access to area where corresponding exposure limits may be exceeded.

Certain occupational groups may have to work close to the base station antennas. For example, occupational exposure is possible during maintenance of base station, as well as during construction and similar tasks on the roof in close proximity to the antenna. These occupations include maintenance and operator personnel, janitors, painters, chimney sweepers, window cleaners, etc., and generally workers that have to work on roof tops and building facades.

Working close by the antenna

Modern base station antennas are sector antennas that transmit only to the forward direction.





If you are working behind the antenna it is likely that the radiofrequency fields are at the background level due to the very good directivity of the transmission. Antennas are often sited on the edges of the roof tops so it can be approached only from behind.

Another general installation place for the antenna is on small mast, chimney or higher on the building wall. In this case the antenna will send the transmission over the heads of people working below antennas. It is therefore safe to work below the antennas. Same principle applies if you are working higher than the antenna. In that case the transmission goes below you and the power densities at working location are well below allowed levels.

In some cases you have to work or walk by the antennas in front of the antennas thru the transmission. A general rule of thumb says that a safe distance is at 1 meter away from the antenna, if you are in front of the antenna, as can be seen in the figure below.

It is also possible to pass by right in front of the antennas without exceeding the restriction levels which averaged over longer time (6 min). If

longer periods of time are spend in safety zone, the teleoperator should be contacted to discuss the transmission powers of that particular base station.

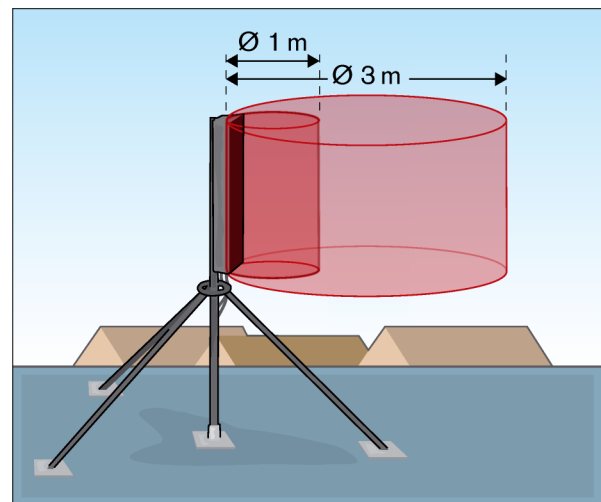

Measurements have shown that to stay for unlimited time you need to be a distance of one meter from the antenna for occupational exposure, and the corresponding limit for the general public is three meters.

An information publication from the EMF NET project

Authors: Tommi Alanko, Finnish Inst. Occup. Health, Helsinki, Finland,
Kjell Hansson Mild, Dept. of Radiation Physics and Monica Sandström,
Occupational and Environmental Medicine, Umeå University, Umeå, Sweden

Phone +46 (0)90 7850000 • <http://web.jrc.ec.europa.eu/emf-net/>

Graphic design and illustrations: Guldbrand & Guldbrand

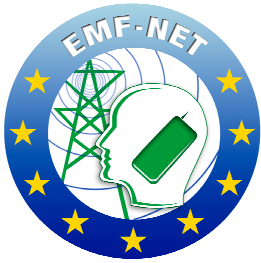

An information publication from the EMF NET project
SSPE-CT-2004-502173 EMF-NET MT2 working group
Effects of the Exposure to Electromagnetic Fields:
From Science to Public Health and Safer Workplace.
Coordination Action 8. Policy Support and Anticipating
Scientific and Technological Needs



Occupational exposure fact sheet

RF wood glue drying

This fact sheet gives practical advice on how to work safely with wood glue drying machines. It also provides information on what radio frequency (RF) electromagnetic fields are and how they can affect your health and what parameters should be measured to make a proper risk assessment.

How does an RF wood glue drying machine work?

Wood glue drying machines are mainly used to quick-dry glue when manufacturing items such as tabletops. A typical wood glue drying machine has an input area where the wood material is fed in and an output area where the material comes out again. Inside the metal casing there are long electrodes to which a RF current is led from a RF generator. Radio frequency current is transferred via the electrodes to the material, which heats up and dries the glue. It usually takes no more than a few minutes of exposure for the glue to dry.

The strength of the RF field depends on which type of machine is being used. Generally, machines with visible, open electrodes (unshielded) are surrounded with stronger fields than machines with enclosed electrodes.

More on RF fields

When describing RF electromagnetic fields, the field's frequency is often mentioned. The permitted operating frequencies for glue dryers are 13.56, 27.12, or 40.68 megahertz (MHz).

There is a risk of interfering with other equipment, such as radio and TV receivers, if other frequencies are used. The manufacturer sets the frequency, but after several years of use it can vary, so it's important to measure the frequency regularly.

The RF fields from a wood glue drying machine spread out around the machine, but most often it is only right next to the machine that the field is so strong that precautions need to be taken. The field's strength decreases sharply with distance from the source.

The strength of the field is given in two different measurements: the electric field strength (E) is measured in volts per metre (V/m), and the magnetic field strength (H) is measured in amperes per metre (A/m). Both of these must be measured to get an idea of how strong the RF field is. The current that goes through you if you touch the



equipment (contact current) and the current that goes through the body when glue drying (induced current) must also be measured.

What are the health risks?

If exposed to radio frequency fields that are too strong, there is a risk that the body will heat up – either the entire body, which can be compared to a fever, or parts of the body, usually the hands and arms. Specific energy Absorption Rate (SAR) in the whole body or part of the body is a widely accepted measure for thermal effects in the RF range.

Another risk is burn injuries that can occur when direct contact is made with the electrode or sometimes with other metal parts of the machine. These burn injuries are often deeper than those you get by burning yourself on a stove at home. This is due to the radio frequency field penetrating somewhat into the tissue.

Which regulations apply to radio frequency fields?

EU has published a directive that apply to the entire European Union. The new EU regulations are not very different from the regulations currently applied to RF exposure in many countries. Read more about the guidelines and corresponding action values in the pamphlet.

Areas where there is a risk for exceeding limits must be clearly marked with warning signs and access must be limited. Signs warning that intense electromagnetic fields occur in the room must be clearly visible at the entrances to the room or facility.

Action values, i.e. max. permitted levels according to the EU directive 2004. Time average over 6 minutes

Electric field strength	61 V/m
Magnetic field strength	0.16 A/m
Induced current	100 mA
Contact current*	40 mA

*Not average

How to measure exposure?

For glue drying machines there is a need to measure all parameters given in the directive: E and H fields, contact and induced current. The fields can be quite strong near the electrode. At normal use the operator is standing at such a distance from the opening in the machine that the action values are not exceeded. However, as the machines have a very long live time and are often rebuilt there is an obvious risk for RF leakage and exceeding of the action values even at operating site.

In preparation for the measurement make sure that you set up a worst case situation.

The measurements have to be done at operating site but also around the machine to detect possible leakage.

Often extensive measurements have to be taken with spatial averaging over the body. Select 4–6 spots– head, chest, groin, thighs – and make the recordings. Note that the measurements have to be done without the operator present, since the fields are strongly distorted by the presence of a person. The spatial averaging have to be measured on the square of E and H value, since the exposure limit is based on SAR which is directly proportional to the these values.

If the averaged value is below the action level the directive is fulfilled. If not the next step is time averaging. The SAR limit is time averaged over any 6 minute period, and the next step will be to see the timing of the exposure and how long duty cycle the process has. This should then be applied to the spatial average value to see how it compares with the action levels.

It is also necessary to measure both the induced and contact currents, see figure below.

When to make measurements?

Control measurements of wood glue dryers should occur regularly every few years or after major

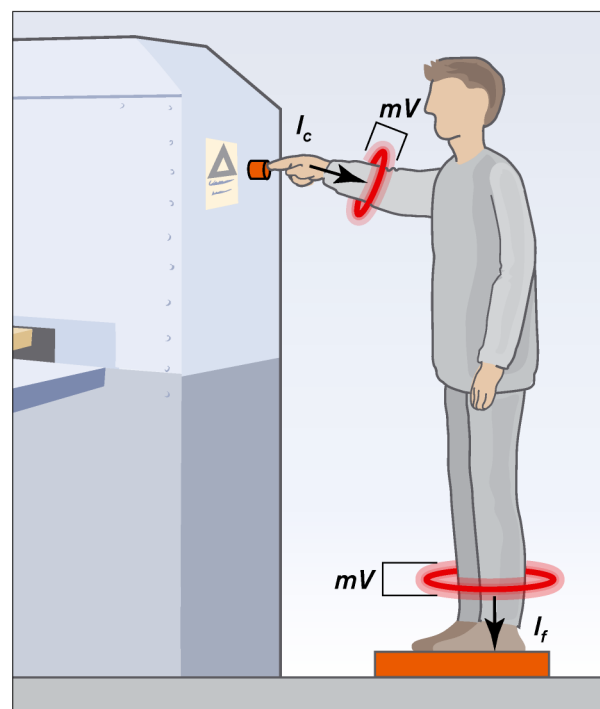

Measurements of contact and induced current in front of a glue drying machine.

changes have been made to the machine. These measurements are difficult to make, and the necessary measuring devices are expensive and you may need to contact experts on electromagnetic field measurements.

How can strong fields be avoided?

Generally, the workplace should be designed in such a way that it isn't necessary for the operator to have direct contact with the machine during the drying process and that there is as much distance as possible between the operator's manoeuvring bench and the inputs and outputs. It is also important that the machine is well maintained and in good condition. It is especially important to ensure that all the screws holding the metal parts together in the machine chassis are in place and properly tightened. The RF fields could otherwise "leak out" from gaps in the panels, screw holes and so on. The machine must also be properly grounded. It is not enough to use the thin copper wires used for grounding ordinary electrical equipment – a proper strip of metal is required. Grounding can be difficult, and you may need to turn to an expert such as the machine's manufacturer for help. However, it is of importance for the exposure that the operator is NOT in contact with ground, because if so the absorption of RF energy will increase substantially. It is therefore recommended that if the floor in the factory is reinforced concrete, which it usually is, then the operator should be standing on a non conducting material that gives

a distance of 5–10 cm from the floor, for instance a rubber mat or some wood platform. Note that this has to be made so that the ergonomics of the workplace is not imperiled.

For completely enclosed processes where the machine is in a separate, shielded room and where employees are not allowed during the drying process, exposure outside the room is often so low that the risk of injury is negligible.

New employees must go through introductory training on how to work safely with glue drying machines.

What about pregnant women?

Currently, there is no collective practice for how this type of work should be regulated for pregnant women. Many glue drying companies temporarily transfer pregnant women so they are not working directly with the machine while they are pregnant.

Would you like to read more?

Directive 2004/40/EG of the European Parliament and of the Council on the minimum health and safety requirements regarding the exposure of workers to the risks arising from physical agents (electromagnetic fields).

Safety in the use of radio frequency dielectric heaters and sealers. Occupational safety and health series 71, International Labour Office (ILO), Geneva. ISBN 92-2-110333-1

- All screws holding the metal chassis together must be in place and properly tightened. It is especially important to remember this after the chassis has been opened.
- The work process must be designed so that the operator stands at the appropriate distance from the glue dryer's opening.
- A wood or plastic platform on the floor reduces the amount of current that is induced in the body.



An information publication from the EMF NET project

Authors: Kjell Hansson Mild, Dept. of Radiation Physics and Monica Sandström, Occupational and Environmental Medicine, Umeå University, Umeå, Sweden

Phone +46 (0)90 7850000 • **<http://web.jrc.ec.europa.eu/emf-net/>**

Graphic design and illustrations: Guldbrand & Guldbrand

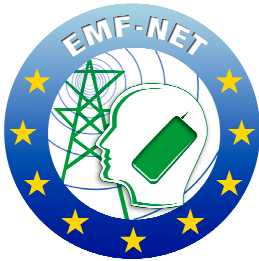

A Fact Sheet publication from the EMF NET project
SSPE-CT-2004-502173 EMF-NET MT2 working group
Effects of the Exposure to Electromagnetic Fields:
From Science to Public Health and Safer Workplace.
Coordination Action 8. Policy Support and Anticipating
Scientific and Technological Needs



Occupational exposure fact sheet

RF plastic welding machines

This fact sheet gives practical advice on how to work safely with plastic welding machines. It also provides information on what radio frequency (RF) electromagnetic fields are and how they can affect your health.

How does an RF plastic welding machine work?

Plastic welding machines are used to join pieces of plastic together into larger pieces, for example, lorry cargo covers and waterproof garments. This is done by using a radio frequency current to melt the material into a watertight seam.

A typical plastic welding machine consists of a radio frequency generator (which creates the radio frequency

current), a pneumatic press, an electrode that transfers the radio frequency current to the material that is being welded and a welding bench that holds the material in place. The machine could also have a grounding bar that is often mounted behind the electrode, which leads the current back to the machine (grounding point). There are different types of machines, the most common being tarpaulin machines, garment machines and automated machines.

By regulating the machine's tuning, the field strength can be adjusted to the material being welded. When welding, the machine is surrounded by a RF field that, if too strong, can heat up the body somewhat. This is what the operator needs to be protected from.



The strength of the RF field also depends on the type of machine being used. Generally, machines with visible, open electrodes (unshielded) have stronger fields than machines with enclosed electrodes.

More on RF fields

When describing radio frequency electromagnetic fields, the field's frequency is often mentioned. The permitted frequencies for plastic welders are 13.56, 27.12, or 40.68 megahertz (MHz).

There is a risk of interfering with other equipment, such as radio and TV receivers, if other frequencies are used. The manufacturer sets the frequency, but after several years of use it can vary, so it's important to measure the frequency regularly.

The radio frequency electric and magnetic fields from a plastic welding machine spread out around the machine, but most often it is only right next to the machine that the field is so strong that precautions need to be taken. The field's strength decreases sharply with distance from the source.

The strength of the field is given in two different measurements: the electric field strength (E) is measured in volts per metre (V/m), and the magnetic field strength (H) is measured in amperes per metre (A/m). Both of these must be measured to get an idea of how strong the radio frequency field is. The current that goes through the operator if in touch with the equipment (contact current) and the current that goes through the body when welding (induced current) must also be measured.

What are the health risks?

If exposed to RF fields that are too strong, there is a risk that the body will heat up – either the entire body, which can be compared to a fever, or parts of the body, usually the hands and arms. Another risk is burn injuries that can occur when direct contact is made with the electrode or sometimes with other metal parts of the machine. These burn injuries are often deeper than those you get by burning yourself on a stove at home. This is due to the RF field penetrating somewhat into the tissue.

Which regulations apply to radio frequency fields?

EU has published a directive that apply to the entire European Union. The new EU regulations are not very different from the regulations currently applied to plastic welding in many countries. Areas where there is a risk for exceeding limits must be clearly marked with warning signs and access must be limited. Signs warning that intense electromagnetic

fields occur in the room must be clearly visible at the entrances to the room or facility.

Action values, i.e. max. permitted levels according to the EU directive 2004. Time average over 6 minutes

Electric field strength	61 V/m
Magnetic field strength	0.16 A/m
Induced current	100 mA
Contact current*	40 mA

*Not average

How to measure exposure?

For RF plastic welding machine there is definitively a need to measure all parameters given in the directive: E and H fields, contact and induced current. The fields can be quite strong near the electrode – note that the electrode voltage to ground can be over 2 kV! It is usually not a question if the action levels are exceeded or not, but rather how close can you come to the machine before they are exceeded.

In preparation for the measurement make sure the plastic used is the one giving the worst case – different plastic materials do have different dielectric properties and thus need different intensity of the RF to get a good weld. Also how many layers of plastic that are to be welded are of importance for the exposure. Make sure that the electrode is at operating temperature before the start of the measurement session.

Often extensive measurements have to be taken with spatial averaging over the body. Select 4–6

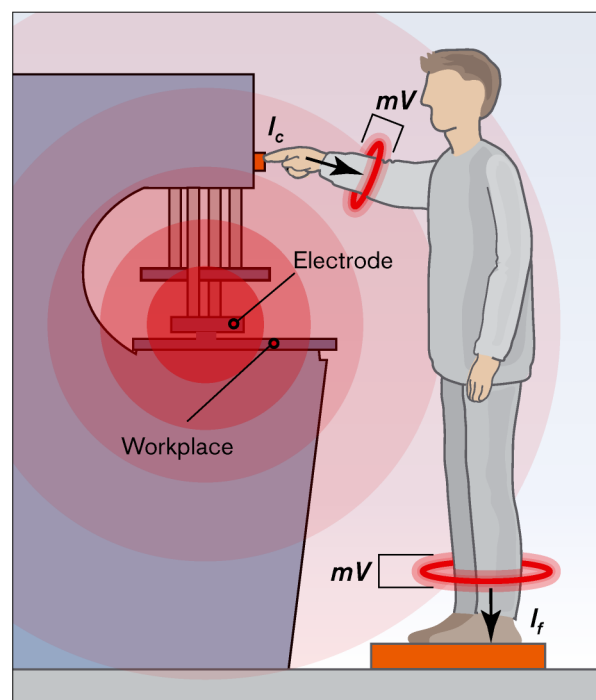

Measurements of contact and induced current in front of an RF sealer.

spots – head, chest, groin, thighs – and make the recordings. Note that the measurements have to be done without the operator present, since the fields are strongly distorted by the presence of a person. The spatial averaging have to be done on the square of the E and H values, since the exposure limit is based on SAR (Specific Absorption Rates, read more in the general text on RF exposure) which is directly proportional to these values.

If the averaged value is below the action level the directive is fulfilled. If not the next step is time averaging. The SAR limit is time averaged over any 6 minute period, and the next step will be to see the timing of the exposure and how long duty cycle the process has. This should then be applied to the spatial average value to see how it compares with the action levels.

When to make measurements?

Control measurements of RF plastic sealer should occur regularly every few years or after major changes have been made to the machine. These measurements are difficult to make, and the necessary measuring devices are expensive and you may need to contact experts on electromagnetic field measurements.

How can strong fields be avoided?

Generally, the workplace should be designed in such a way that it isn't necessary for the operator to have direct contact with the machine while welding and that the welding electrode is placed as far away from the operator as possible.

It is also important that the machine is well maintained and in good condition. It is especially important to ensure that all the screws holding the metal parts together in the machine chassis are in place and properly tightened. The radio frequency fields could otherwise "leak out" from gaps in the panels, screw holes and so on. It is very important to use a grounding bar. If it is dismantled, the return current will not go back to the ground point and exposure will increase considerably around the machine. The grounding bar will not function as it should if too much plastic material comes between the bar and the bench.

The machine must also be properly grounded. It is not enough to use the thin copper wires used for grounding ordinary electrical equipment – a proper strip of metal is required. Grounding can be difficult, and you may need to turn to an expert such as the machine's manufacturer for help. However, it is of importance for the exposure that the operator is NOT in contact with ground, because if so the absorption of RF energy will increase substantially. It is therefore

recommended that if the floor in the factory is reinforced concrete, which it usually is, then the operator should be standing on a non conducting material that gives a distance of 5–10 cm from the floor, for instance a rubber mat or some wood platform. Note that this has to be made so that the ergonomics of the workplace is not impeded.

New employees must go through introductory training on how to work safely with a plastic welding machine.

- One way of avoiding direct contact with the machine when welding while standing is to use a starter rope.
- All screws holding the metal chassis together must be in place and properly tightened. It is especially important to remember this after the chassis has been opened.
- Two-hand grip when starting to weld while sitting. For instance, the start button can be mounted on the chair to avoid direct contact with the machine while welding.

What about pregnant women?

Currently, there is no collective practice for how this type of work should be regulated for pregnant women. Many plastic welding companies temporarily transfer pregnant women so they are not working directly with the machine while they are pregnant.

Would you like to read more?

Radio frequency electromagnetic fields from plastic welders. Measurements and reduction measures. Investigative report 1983:24, National Institute for Working Life, Stockholm, ISSN 0347-2248

Guidelines for the measurement of RF welders. Investigative report 1991:8, National Institute for Working Life, Stockholm, ISSN 0284-7620

Directive 2004/40/EG of the European Parliament and of the Council on the minimum health and safety requirements regarding the exposure of workers to the risks arising from physical agents (electromagnetic fields).

IEEE Std C95.3. Recommended practice for measurements and computations of radio frequency electromagnetic fields with respect to human exposure to such fields, 100 kHz-300 GHz. Published by the Institute of Electrical and Electronics Engineers, New York, USA, 2002.

Safety in the use of radio frequency dielectric heaters and sealers. Occupational safety and health series 71, International Labour office (ILO), Geneva. ISBN 92-2-110333-1

An information publication from the EMF NET project

Authors: Kjell Hansson Mild, Dept. of Radiation Physics and Monica Sandström, Occupational and Environmental Medicine, Umeå University, Umeå, Sweden

Phone +46 (0)90 7850000 • **<http://web.jrc.ec.europa.eu/emf-net/>**

Graphic design and illustrations: Guldbrand & Guldbrand

Assessment of occupational exposure to intermediate frequency electromagnetic fields in practice

Jolanta Karpowicz, Krzysztof Gryz

ver. 1 - April 2008

INTRODUCTION

Electric currents and voltages produce electromagnetic fields (EMF).

The majority of population are subject to simultaneous exposure to EMF from broadcasting and power distribution installations, as well as various electrical appliances. The characteristics of EMF in the workplace is often very specific in comparison with the fields in the general public environment:

- in the workplace the locations of the EMF source against the worker's body can change significantly
- distance between the source and the human body can be very short
- the worker's body can even touch EMF source
- geometry of the source, frequency and level of EMF produced by it can also be unstable
- exposure level of an operator can vary significantly also as a result of his physical activity in the vicinity of the source
- the worker's exposure level can be high, even exceeding international safety guidelines.

EMF exposure assessment adequate to the physical characteristics of exposure and real exposure level is the crucial step towards appropriate:

- risk assessment for occupational safety and health (OSH) engineering
- testing the compliance of exposure conditions with safety guidelines or requirements from legislation
- design or re-design of devices emitting EMF and work environment containing such sources
- epidemiological studies of EMF-exposed groups
- environmental monitoring.

The strongest demands for the use of detailed EMF exposure assessment protocol come from the regulations concerning mandatory control of occupational or environmental EMF exposure, e.g. European Directive on workers EMF exposure limitation or national legislation on occupational safety and health.

ENVIRONMENTAL EMF OF INTERMEDIATE FREQUENCY RANGE (IF)

EMFs of frequency from the range of 300 MHz – 300 GHz are called microwaves (MW). Wavelength of MW is sufficiently short for the practical use of waveguides to transmit or receive it. EMF of any frequency, which is useful for telecommunication, is called radiofrequency (RF) EMF. It is possible to find various definitions of RF, e.g. 300 Hz – 300 GHz (according to IEEE).

EMFs of the frequency below 300 Hz are called extremely low frequency (ELF) fields. Power frequency means the frequency of currents used for electrical power transmitting and of EMFs it produces (50 Hz in Europe, 60 Hz in North America).

The Intermediate Frequency (IF) range of EMF spectrum is specified as the band between the extremely low frequency (ELF) and radio frequency (RF) ranges. The limits of IF range is not defined univocally (e.g. according to WHO fact sheet it is the range from 300 Hz to 10 MHz) (see Figure 1). The basic parameters of IF EMF are presented in Table 3.

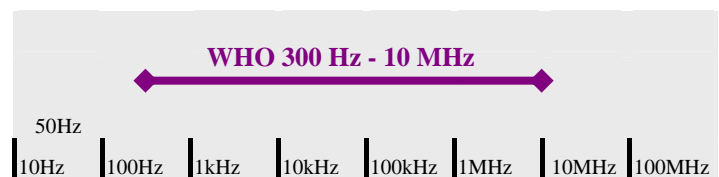

Figure 1. Example of definition for IF EMF

The basic properties of EMF are related to the wavelength and field polarisation, characterised by the so-called near- or far-field condition of exposure (see Table 1).

IF EMF which exists in the work environment is usually near field.

Electric field strength, E , and magnetic field strength, H , should be considered for the assessment of IF EMF.

Table 1. Basic parameters of IF EMF

Frequency, f	Wavelength, λ , m	Near field approximation – distance from field source - up to λ , m	Far field approximation – distance from field source - exceeding 3λ , m
50 Hz	6000000	6000000	18000000
300 Hz	1000000	1000000	3000000
1 kHz	300000	300000	900000
10 kHz	30000	30000	90000
100 kHz	3000	3000	3000
1 MHz	300	300	900
10 MHz	30	30	90
27 MHz	11	11	33
100 MHz	3	3	9

HAZARDS CAUSED BY IF EMF

Within IF EMF, three basic mechanisms related to direct adverse effects in the living matter were established:

- effects of exposure to time-varying electric fields - a flow of electric current, polarisation and reorientation of electric dipoles already present in the tissue (dominating up to 100 kHz, but under consideration up to 5-20 MHz)
- effects of exposure to time-varying magnetic fields - induced electric fields and circulating electric currents, the so-called eddy currents in the body (dominating - up to 100 kHz, but those under consideration - up to 5-20 MHz)
- effects of absorption of energy from EMF - temperature increase inside the exposed body (under consideration - above 100 kHz, but the dominant - above 10 MHz).

Except direct effects of EMF exposure and interaction of EMF with the human body, indirect effects can be a significant source of hazards such as:

- contact currents
- coupling of EMF to medical devices
- transient discharges (sparks).

EXPOSURE ASSESSMENT CRITERIA APPLICABLE FOR IF EMF

Exposure assessment regarding IF EMF is extremely complex – almost all estimators of EMF can be used in this case:

Internal measures:

- SAR
- induced currents
- *in situ* electric field

External measures

- electric field strength (E)
- magnetic field strength (H)
- magnetic flux density (B)

- contact and induced currents flowing through the limbs (I).

Various estimators can be necessary for the assessment of EMF of different patterns:

- RMS value
- peak value
- time derivative dB/dt
- exposure factor
- time-averaged exposure level
- spatially-averaged field strength
- spatially-averaged squared field strength, etc.

All estimators (except SAR) have been established as frequency-dependent exposure limitations and they refer to various frequency ranges.

MEASUREMENTS OF IF EMF

The assessment of IF EMF can be based on the results of the series of spot measurements of RMS value of unperturbed electric and magnetic field strength.

The first step of the assessment procedure can be based on searching for maximum over the worker's body position. If the results are above the limit of exposure then the next step could be time averaging, if relevant time-averaged exposure limitation is available, e.g. 6-minutes averaging of E and H-fields of the frequency above 100 kHz.

For the case when the worker's body is in contact with electric field sources, the above mentioned level of exposure should be established significantly below environmental limit for unperturbed field (like action values from EMF directive) because spatial distribution of exposure is heterogeneous and there is a risk of exceeding the local thermal effect. The details should be discussed with the use of the results of numerical calculations and contact/induced currents measurements. The use of commercial broadband RMS electric and magnetic field strength meters should be very carefully considered in the case of highly modulated fields. Laboratory tests indicate that correction factors for modulated fields can be established for typical waveforms, but uncertainty of such procedure will significantly rise in comparison with measurements of sinusoidal waves.

In the case of hand operating sources of strong electric field or contact of the worker's body with their elements, the assessment of induced current resulting from coupling between workers body and element with high electric potential (e.g. active electrode or cable of electrosurgery unit) is problematic. The EMF directive criteria for induced current in limbs are not given for frequency below 10 MHz, however local thermal effect in the limbs

(local SAR) was limited for frequencies exceeding 100 kHz. The assessment of these quantities may be carried out following the permissible values as specified in the directive for contact current or permissible values for induced current in the feet specified in IEEE standard. Very few instruments measuring current flowing through limbs (clamp-on meter or stand-on meter) are currently available.

The following basic problems with EMF measurements and assessment of workers exposure were specified:

- heterogeneous distribution of EMF cause measurement error as a result of field averaging over the EMF sensor
- measurements in direct proximity of the powered cables or other elements of EMF sources at high electric potential are connected with strong coupling between the meter probe and EMF source what can influence on the meter sensitivity and lead to additional measurement error not covered by calibration of the device
- according to general rules, the assessment of the worker's exposure should be based on unperturbed field. In many cases, e.g. of electrosurgical devices, measurement of this field is not possible for technical reasons. Exposure assessment performed during simulated work of EMF sources does not take into account the results of capacitive coupling and induced or contact current flowing through the worker's body
- EMF measurements over the position of trunk not cover the hands' exposure, usually the most exposed part of body.
- use of meters calibrated in harmonic reference field for measurements of pulse modulated field may be a source of additional significant measurement error.

NUMERICAL CALCULATIONS

According to the provisions of European Directive 2004/40/EC, in the case of environmental exposure conditions exceeding limits given for *exposure action values*, workers' exposure assessment should be performed on numerical calculations of physical quantities inside numerical phantom of exposed body, i.e. *exposure limit values*, such as current density (J) and specific energy absorption rate (SAR). The conclusive assessment of workers exposure to EMF needs the use of the worker's body models (numerical phantoms) and an adequate representation of the workplace.

The basic problems for calculations are:

- representation of the realistic posture of the worker's body
- adequate representation of the electrical grounding conditions at the workplace
- adequate representation of realistic impedance of near-field produced by devices being use
- adequate representation of dynamic changes of EMF level in the course of working activity.

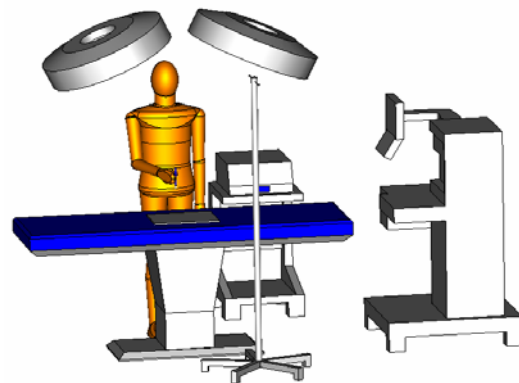

Fig. 2. Numerical model of exposure conditions, realistic for surgeon's exposure from electrosurgery device

Adequate calculations for assessment of particular exposure situations need high professional skills, specialised software and can be very time-consuming and expensive.

OCCUPATIONAL EXPOSURE TO IF EMF

Significant occupational exposure to EMF from the IF range is caused by various:

- industrial appliances:
 - o induction heaters, operating usually from 1 kHz to low MHz
 - o welding devices, common sources of ELF EMF but can be also a source of EMF of tens/hundreds kHz frequency
- medical devices (electrosurgery units, usually sources of 300 kHz - 1.5 MHz)
- anti-theft devices and many others.

Usually, impedance of EMF in the workplace is high or low in comparison with $Z_0=377\Omega$ and in consequence, exposure assessment can be executed on the basis of testing only one dominating component, e.g. magnetic in the case of induction heaters or electric in the case of electrosurgery.

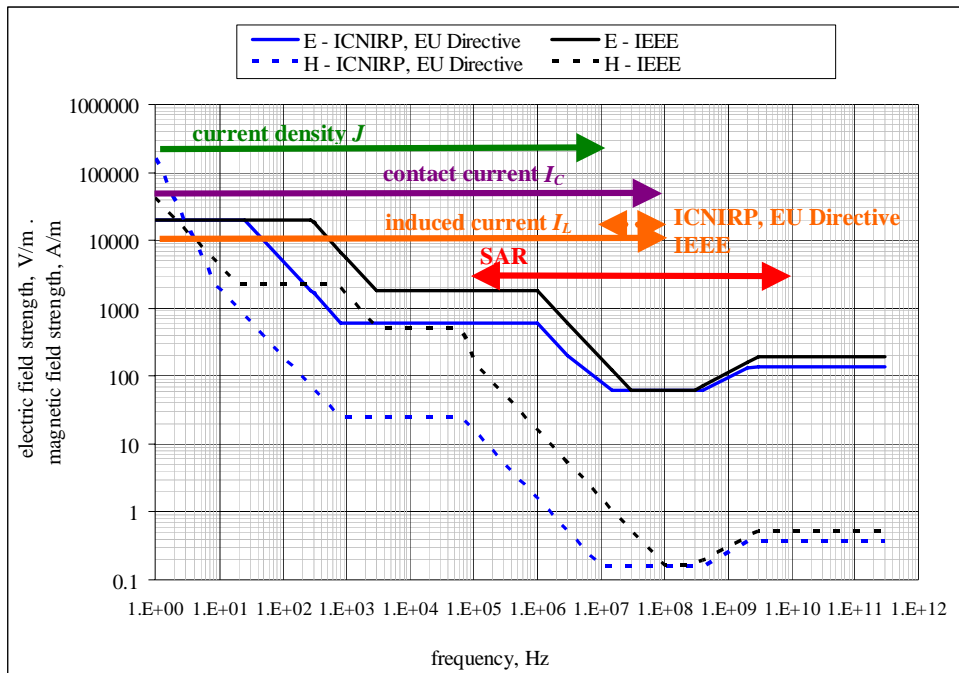

Figure 3. Internal and external measure applicable for the assessment of IF EMF

Comments:

According to the European Directive, the worker's exposure assessment should be performed on the results of measurements of RMS value of unperturbed (existing in the workplace during the absence of workers) electric and magnetic field strength averaged over the workers body position and averaged for particular time, which depends on the frequency of assessed fields (e.g. for the EMF of the frequency 100 kHz - 10 GHz, *E* and *H* should be averaged within any 6 minutes of worker's exposure and *E*² and *H*² should be averaged over the worker's body position).

Worker's exposure assessment can be performed on the results of a spatial averaging RMS value in the straight line in the center of the projected area – equal to worker's position (according to IEEE standard) or on results of the spot measurements of RMS value (the maximum result of measurements over the worker's body position in the workplace).

According to Directive 2004/40/EC in the cases of non-sinusoidal EMF exposure peak "action values" for the field strengths are calculated by multiplying the relevant RMS values by coefficient (i.e. multiplied by approx. 1.5 for 100 kHz, 4.4 for 500 kHz, 6.9 for 1 MHz).

References

1. Directive 2004/40/EC of the European Parliament and of the Council of on the minimum health and safety requirements regarding the exposure of workers to the risks arising from physical agents (electromagnetic fields) (18th individual Directive within the meaning of Article 16(1) of Directive 89/391/EEC), O.J. Nr L-184, 2004.
2. ICNIRP Guidelines for Limiting Exposure to Time-Varying Electric, Magnetic, and Electromagnetic Fields (up to 300 GHz), Health Physics, 1998, 74, 4 (April), 494-522.
3. IEEE Std C95.1, Standard for Safety Levels with Respect to Human Exposure to Radio Frequency Electromagnetic Fields, 3 kHz to 300 GHz. 2005 Edition Published by the Institute of Electrical and Electronics Engineers, New York, USA, 2006.
4. Internet service: <http://www.ciop.pl/EMF>

Jolanta Karpowicz (jokar@ciop.pl), Krzysztof Gryz (krgrzy@ciop.pl)
 Central Institute for Labour Protection - National Research Institute (CIOP-PIB), Laboratory of Electromagnetic Hazards
 Czerniakowska 16, Warszawa, POLAND, <http://www.ciop.pl> & <http://www.ciop.pl/EMF>



This issue was compiled in relation to activities of EMF-NET project and is related to the following deliverables: D50 (WP10), D53 (WP11), D56 (WP11.1), D59 (WP11.2), D62 (WP11.3), D67 (WP12), D72 (WP12.1) and D77 (WP12.2).

Contract no.	SSPE-CT-2004-502173
Project acronym:	EMF-NET
Project title	Effects of the Exposure to Electromagnetic Fields: From Science to Public Health and Safer Workplace
Instrument	Coordination Action
Thematic Priority	8. Policy Support and Anticipating Scientific and Technological Needs

The results of National Programme "Adaptation of Working Conditions in Poland to European Union Standards" supported by the State Committee for Scientific Research of Poland, international project "Centre for Testing and Measurement for Improvement of Safety of Products and Working Life" (European Union 5th Framework Programme) were also used for compilation, as well as results of investigations executed in the cooperation with enterprises.

ELECTROSURGERY

Occupational exposure to electromagnetic fields - assessment in practice

Krzysztof Gryz, Jolanta Karpowicz

ver. 1 - April 2008

ELECTROSURGERY DEVICES

Electrosurgery means the use of electric currents to cut or to coagulate a patient's tissues for various medical treatments. The sources of occupational exposure to electromagnetic fields (EMF) include:

- an active electrode at a high electric potential
- cables connecting the generator (output power of up to 500 W, usually during surgical treatment of 50-150 W) with the active electrode, held in the hand by a surgeon, and with the passive electrode (grounded plate), mounted to the patient's body (Fig. 1)
- a generator in case of not leak-proof housing (generator with insufficient electromagnetic shield)
- metallic objects located in the vicinity of cables (e.g. surgical or instrumentation tables), which can become secondary sources of EMF.

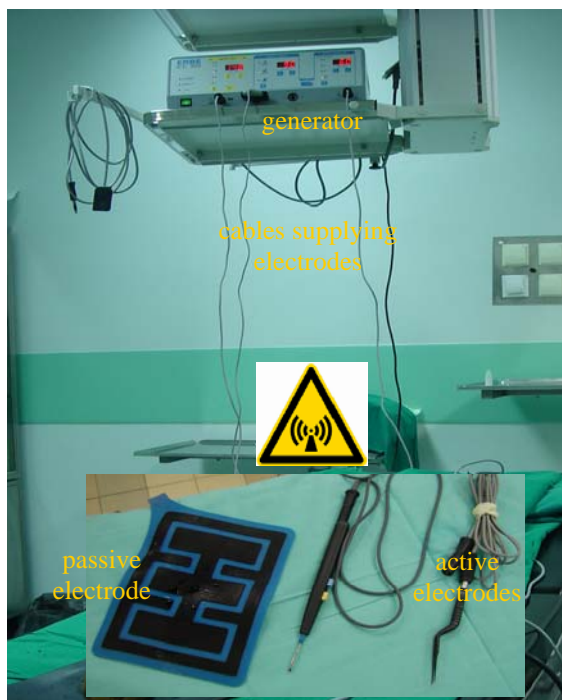

Fig. 1. Electrosurgery device

OCCUPATIONAL EMF EXPOSURE

Electrodes and supplying cables are sources of electric field (E-field) of high level because of the application of supplying intermediate frequency (IF) high voltage, of frequency exceeding 300 kHz (up to ~1 MHz).

The waveforms of EMF produced in the vicinity of cables depend on a type of a device and its mode of operation (Fig. 2).

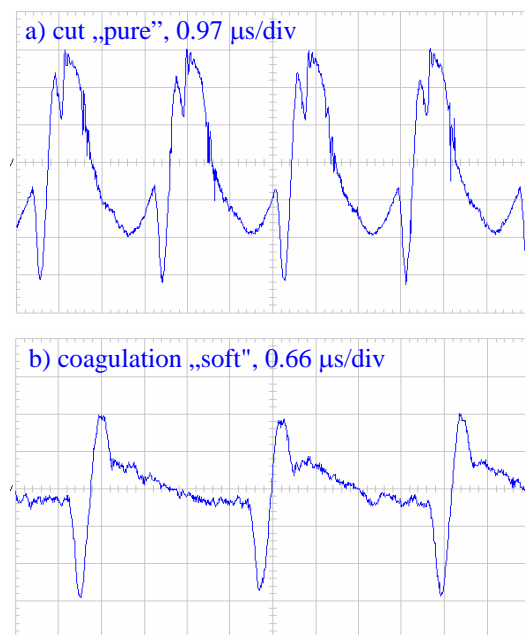

Fig 2. EMF of electrosurgery device - E-field v. time

The exposure to EMF of a surgeon and health care staff (attending physicians and nurses) depends on:

- mode of device operation
- type of active electrode in use
- location of cables connecting electrodes with generator.

The surgeon, who holds an active electrode in the hand, is usually the most exposed person from the team.

The hand exposure always exists, but other areas of the body can be also exposed as a result of a contact with cables, e.g. head or torso EMF exposure.

The surgeon is usually exposed to non-homogenous E-field. Metallic objects, which are in the operating theatre influence the spatial distribution of E-field. The level of exposure of health care staff can change 2 or 3 fold, as a consequence of changes in the location of these objects.

In the worst case (use of a monopolar electrode and non-shielded cables, approx. 100-150 W output power), the surgeon's hand can be exposed to E-field exceeding 1000 V/m, but head and torso - up to a few tens of V/m only. When cables touch the surgeon's body then torso exposure is stronger, up to the level of the exposure of the hand holding the electrode. Magnetic field (H-field) is usually below 1 A/m in the distance of 5-10 cm from electrodes and cables. If cables create loops, an increased magnetic field exists also in their vicinity.

Level and waveform of EMF depend on the mode of electrosurgery devices operation (Fig. 3, Tab. 1).

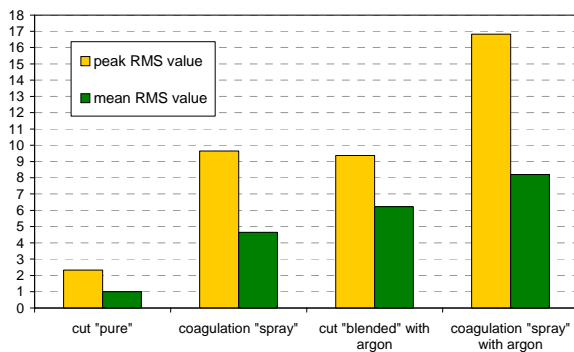

Fig. 3. Examples of variability of E-field produced in various modes of electrosurgery devices - comparison of relative E-field (mean RMS for "pure" cut = 1), registered by wide-band E-field meter

Table 1.

Example of relation of peak value (E_p) to mean RMS values (E_{RMS}) of E-field strength, registered by oscilloscopic method in the vicinity of cables of electrosurgery devices

Operation Mode - output power	Ratio, E_p/E_{RMS}	Waveform of EMF
cut „pure” - 150 W	1,4	sinusoidal 400 kHz
coagulation „spray” - 100 W	4,1	sinusoidal 400 kHz + pulse modulation 25-40 kHz
cut „blend” with argon - 100 W	1,8	sinusoidal 400 kHz + amplitude modulation 27 kHz
coagulation „spray” with argon - 100 W	3,8	sinusoidal 400 kHz + pulse modulation 40 kHz

The execution of electrosurgical treatment with an electric arc burned under an active electrode leads

to a significant increase of E-field affecting on medical staff. The level of exposure during electric arc-surgery can be 4-fold higher in comparison to the operation without visible arc.

As a result of exposure to E-field and capacitive coupling between elements of electrosurgery device and the worker's body, induced electric current is flowing through the worker's body, similarly to currents penetrating the patient's tissues (Fig. 4).

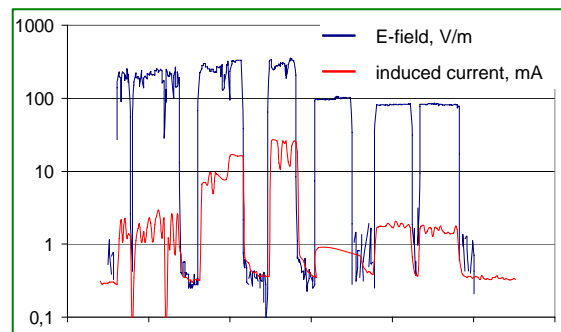

Fig. 4. Induced current measured at surgeon's hand, keeping an active electrode, and E-field measured over a surface of this hand (for various modes of operation and cable location, 5-minutes registration)

OCCUPATIONAL EMF EXPOSURE ASSESSMENT

Measurements

The level of EMF exposure of health care staff can be assessed with the use of three parameter, which can be measured in the workplace:

- electric field strength, E , in V/m
- magnetic field strength, H , in A/m
- induced current, I , in mA.

The measurements of EMF have to be executed by broadband meters. The frequency response of equipment used for measurements has to be adequate to the frequency of EMF produced by electrosurgery devices.

EMF exposure of health care staff should be measured following the procedures established by requirements of national regulations and standards, or in the case of the lack of such documents, following the internationally published standards (e.g. CENELEC or IEEE standard). The use of the results of laboratory measurements of EMF emission from electrosurgery devices is very limited because spatial distribution of E-field can be highly modified by the metallic structures and humans present in the vicinity of the field source.

The results of measurements of exposure parameters have to be analysed following the national regulations and standards, or in case of the

lack of such document, following the internationally published limitations and standards (e.g. European Directive 2004/40/EC, ICNIRP's guidelines or IEEE standard – see table 2). It should be considered that the permissible level of exposure, applicable for assessment of exposure from various modes of operation of electrosurgery devices, can be different as a result of the use of frequency-dependent exposure limitations.

Methods of measurements should be harmonised with assessment criteria (see Table 2 and 3).

Analysis of results of RMS measurements of E , H , I should take into account the waveforms of the investigated EMF - the most universal method for its identification is oscilloscopic registration. In case of modulated fields, the broadband meters calibrated for RMS value of sinusoidal fields can produce a significant error (exceeding 50 %) and correction factors harmonized with the waveforms of the assessed field should be considered before performing the worker's exposure assessment. As a consequence, for measurements of modulated EMF it is necessary to identify the waveform of EMF time-variability, as well as information on detailed technical parameters of the meter being used concerning the sensitivity of readings of this meter to various parameters of modulated fields. Exposure assessment criteria can also be modified in case of modulated fields (see Table 2 and 3).

Measurements can be performed during a simulated operation only, with phantom equivalent to the patient's body (e.g. absorbent cotton with saline, fresh fruit, vegetable, meat, etc.).

Assessment of surgeons exposure can be performed on the basis the measurements of RMS value of current flowing through the surgeon's hand holding an active electrode and through his feet, performed with the use of clamp-on meter (Fig. 5).

Criteria for induced current in limbs, given in the Directive 2004/40/EC, do not cover frequency below 10 MHz. Limitation of induced current of the frequency from the range typical for EMF produced by electrosurgery devices were published by IEEE standard (Table 3).



Fig. 5. The clamp-on meter for measurements of the current in the surgeon's hand

Numerical calculations

According to the provisions of European Directive 2004/40/EC in case of environmental exposure conditions exceeding limits given for *exposure action values*, the workers' exposure assessment should be performed using numerical calculations of physical quantities inside the numerical phantom of exposed body, i.e. *exposure limit values*, such as current density (J) and specific energy absorption rate (SAR). The conclusive assessment of the surgeon's exposure to EMF needs the use of the worker's body models (numerical phantoms) and an adequate representation of the workplace (Fig. 6).

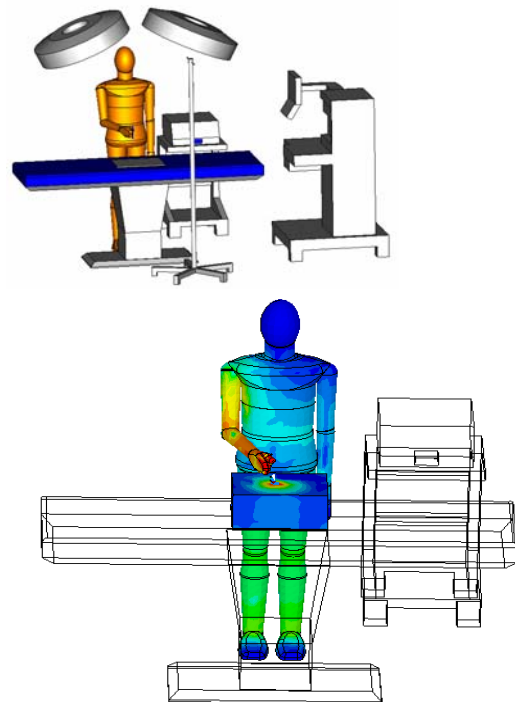

Fig. 6. Numerical simulations of the surgeon's exposure to EMF (numerical model and SAR distribution)

The basic problems for calculations are as follows:

- representation of the realistic posture of the worker's body
- adequate representation of the electrical grounding conditions at the workplace
- adequate representation of realistic impedance of near-field produced by electrosurgery devices
- adequate representation of dynamic changes of EMF level in the course of surgery treatment.

For the surgeon's EMF exposure, adequate calculations for assessment of particular exposure situations need high professional skills, specialised software and can be very time-consuming and expensive.

EMF EXPOSURE REDUCTION

In consideration of a necessity to hold an active electrode in the hand, complete elimination of the surgeon's exposure is not possible. The exposure level of other persons from medical staff is relatively weak if they do not have contact with cables. The reduction of the workers exposure can be obtained when the location of cables supplying a monopolar electrode is proper (e.g. when cables are

kept between a generator and surgeon's hand without contact with the body of any worker).

A radical reduction of EMF exposure level is rendered possible by the use of the bipolar electrode if it can be applied for a particular surgical treatment.

Table 2.

Electric and magnetic field strength – exposure limitation by Directive 2004/40/EC and by IEEE Standard

Frequency range	Directive 2004/40/EC		IEEE Std C95.1,	
	Electric field strength E , V/m	Magnetic field strength H , A/m	Electric field strength E , V/m	Magnetic field strength H , A/m
0.1 MHz < f ≤ 1 MHz	610	1.6/ f	1842	16.3/ f
1 MHz < f ≤ 10 MHz	610/ f	1.6/ f	1842/ f	16.3/ f

f - frequency in MHz

Table 3.

Induced current – exposure limitation by European Directive 2004/40/EC and by IEEE Standard

Frequency range	Directive 2004/40/EC	IEEE	
	Limb induced current I_L , mA	Induced current in feet, I_L , mA	
		each foot	both feet
0.1 MHz < f ≤ 10 MHz	not specified	100	200
10 MHz < f ≤ 110 MHz	100	100	200

Comments:

According to the provisions of European Directive, workers' exposure assessment should be performed on the results of measurements of RMS value of unperturbed (existing in the workplace during the absence of workers) electric and magnetic field strength averaged over the workers body position and averaged in particular time, which depends on the frequency of investigated fields (e.g. for the EMF of the frequency 100 kHz - 10 GHz, E and H should be averaged within any 6 minutes of worker's exposure and E^2 and H^2 should be averaged over the worker's body position.

Worker's exposure assessment can be performed on the results of a spatial averaging of RMS value, performed in relation to the straight line in the center of the projected area – equal to worker's position (according to IEEE standard) or on results of the spot measurements of RMS value (the maximum result of measurements over the worker's body position in the workplace).

According to Directive 2004/40/EC, in cases of exposure to non-sinusoidal EMF, as produced by electro-surgery devices, peak "action values" for the field strengths are calculated by multiplying the relevant RMS values by coefficient (i.e. multiplied by approx. 1.5 for 100 kHz, 4.4 for 500 kHz, 6.9 for 1 MHz).

References

1. Directive 2004/40/EC of the European Parliament and of the Council of on the minimum health and safety requirements regarding the exposure of workers to the risks arising from physical agents (electromagnetic fields) (18th individual Directive within the meaning of Article 16(1) of Directive 89/391/EEC), O.J. Nr L-184, 2004.
2. ICNIRP Guidelines for Limiting Exposure to Time-Varying Electric, Magnetic, and Electromagnetic Fields (up to 300 GHz), Health Physics, 1998, 74, 4 (April), 494-522.
3. IEEE Std C95.1, Standard for Safety Levels with Respect to Human Exposure to Radio Frequency Electromagnetic Fields, 3 kHz to 300 GHz. 2005 Edition Published by the Institute of Electrical and Electronics Engineers, New York, USA, 2006.
4. Internet service: <http://www.ciop.pl/EMF>

ELECTROSURGERY - Occupational exposure to electromagnetic fields - assessment in practice

Krzysztof Gryz (krzyg@ciop.pl), Jolanta Karpowicz (jokar@ciop.pl)

Central Institute for Labour Protection - National Research Institute (CIOP-PIB), Laboratory of Electromagnetic Hazards

Czerniakowska 16, Warszawa, POLAND, <http://www.ciop.pl> & <http://www.ciop.pl/EMF>



This issue was compiled in relation to activities of EMF-NET project and is related to the following deliverables: D50 (WP10), D53 (WP11), D56 (WP11.1), D59 (WP11.2), D62 (WP11.3), D67 (WP12), D72 (WP12.1) and D77 (WP12.2).

Contract no.	SSPE-CT-2004-502173
Project acronym:	EMF-NET
Project title	Effects of the Exposure to Electromagnetic Fields: From Science to Public Health and Safer Workplace Coordination Action
Instrument	
Thematic Priority	8. Policy Support and Anticipating Scientific and Technological Needs

The results of National Programme Adaptation of Working Conditions in Poland to European Union Standards supported by the State Committee for Scientific Research of Poland, international project Centre for Testing and Measurement for Improvement of Safety of Products and Working Life (European Union 5th Framework Programme) were also used for compilation of this issue, as well as results of investigations executed in the cooperation with enterprises.



An information publication from the EMF NET project
SSPE-CT-2004-502173 EMF-NET MT2 working group
Effects of the Exposure to Electromagnetic Fields:
From Science to Public Health and Safer Workplace.
Coordination Action 8. Policy Support and Anticipating
Scientific and Technological Needs



Occupational exposure fact sheet

Occupational EMF Exposure Database

<http://www.occupemf.info/>

The *Occupemf*-database is a unique repository for scientific articles related to occupational exposure to electromagnetic fields (EMF). It is designed to be a tool in searching for information on health risk evaluations of EMF exposure associated with various occupations. The database gives references to relevant scientific papers and reports, and in particular, the *Occupemf*-database contains the products of EMF-NET MT2 project (including the Fact Sheets) in downloadable format, aimed to be freely used by all parties interested in occupational EMF aspects.



Table			
id	title	author	journal
	Occupational exposure to	Alaska T	Radiation prote

The articles can be searched according to article titles, authors, publication year and free text search. The searches can be made conveniently with one search questionnaire field. In addition to conventional targets, the articles can also be searched using occupation or EMF sources as a search parameter. The database search function enables also finding of articles focusing on different frequencies (single frequencies or frequency ranges). Furthermore, the articles are sorted according to the exposure assessment method (measurements, calculations, epidemiological study).

The *Occupemf*-database contains the products of EMF-NET MT2 project (including the Fact Sheets) in downloadable format, aimed to be freely used by all parties interested in occupational EMF aspects.



Detailed instruction for the use can be found at the EMF-NET database web pages <http://www.occupemf.info/>

<http://www.occupemf.info/>

*An information publication from the EMF NET project
Authors: Tommi Alanko and Maila Hietanen, Finnish Institute of Occupational Health, Helsinki, Finland.
Phone +358 (0)30 4741 • <http://web.jrc.ec.europa.eu/emf-net/>*



Practical Guidance for Occupational Low Frequency Exposure Assessment



An information publication from the EMF NET project SSPE-CT-2004-502173 EMF-NET
Effects of the Exposure to Electromagnetic Fields: From Science to Public Health and Safer
Workplace. Coordination Action 8. Policy Support and Anticipating Scientific and Technological Needs

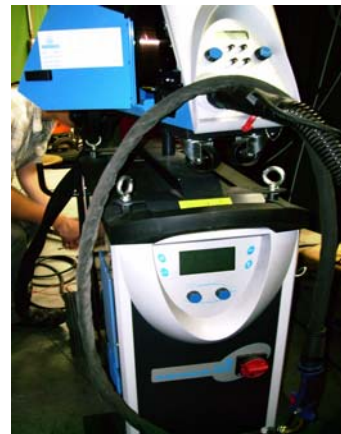

Industry or the workplace in general is a very vast domain of low frequency fields (LF's) electromagnetic fields (EMF's) from which the extreme low frequency (ELF: 30 – 300 Hz) field sources are important representatives. Since there is still no clear definition about the borderlines of the frequency ranges within the non-ionising frequency spectrum the LF's where this guidance is dealing with range from 0 Hz up to 20 kHz. Since every electrical device, apparatus or machine is in fact an ELF EMF source, there are so many sources that it is impossible to consider them all. Hence, the guidance is only based on our experience with the exposure assessment of the most important industrial high exposure LF sources:

- electrical installation for electrolysis (0 Hz)
- electrical arc furnace (50 Hz)
- induction ovens (300 Hz – 10 kHz)
- arc welding (DC, AC, DC-ripple)
- resistance or spot welding (50 Hz – 20 kHz)

What is an Electromagnetic field?

The **electromagnetic field** (EMF) is a combination of an electric and magnetic field propagating in a wavelike manner..

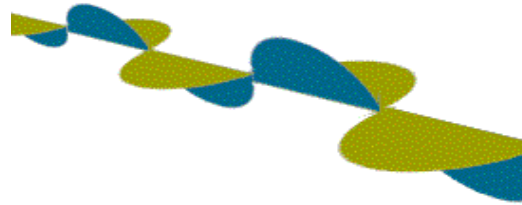

It is characterised by wave length, frequency and quantum energy. The lower the frequency, the lower the quantum energy, the longer the wave length and the longer the penetration depth.

LF classification in the electromagnetic frequency spectrum?

EMF's are classified in a electromagnetic frequency spectrum divided in the spectrum for non-ionising radiation (0 Hz – 3 PHz, $E < 12.4$ eV) and ionising radiation ($f > 3$ PHz and $E > 12.4$ eV). Notice that the energy of non-ionising radiation and certainly the LF's is much too weak to ionise matter.

Frequency spectrum

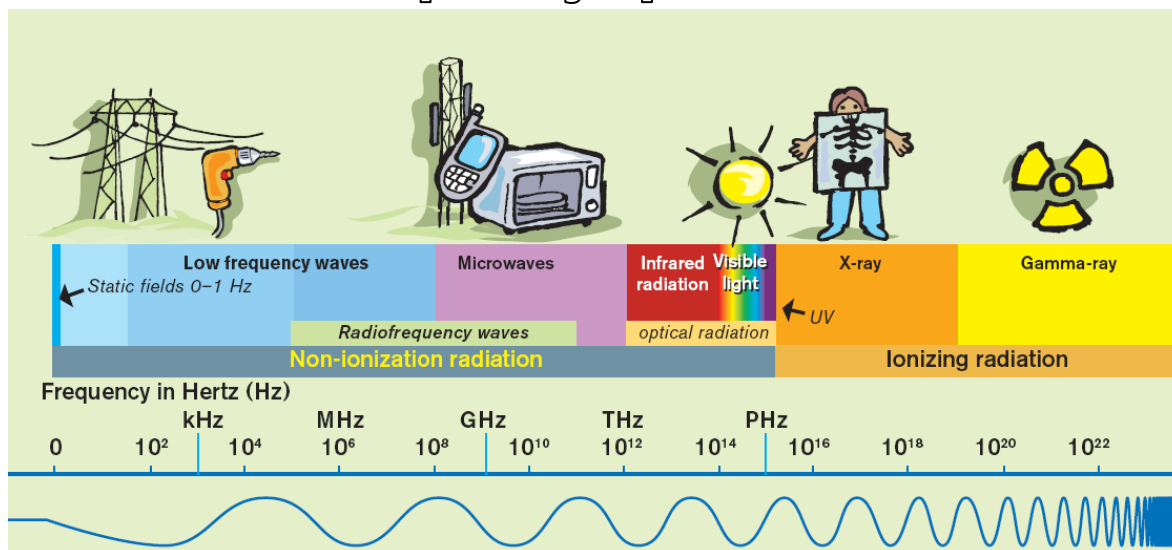

(source RF-guidance 2008)

After the electromagnetic frequency spectrum the LF EMF's are defined as being fields up to about 100 kHz. At this frequency the wavelength [$\lambda = c/f$ ($c = \text{velocity of light} = 3 \cdot 10^8 \text{ m/s in vacuum}$)] is

3 km. When we calculate the wave length for our exposure assessment applications we find ∞ at 0 Hz, 6000 km at 50 Hz, 1000 km at 300 Hz, 30 km at 10 kHz and 15 km at 20 kHz. In this frequency range workers are always exposed in near-field

conditions where, in contradiction to the far-field exposure, the ratio of the electric (E) and the magnetic (H) is different from the 377 ohms (Ω) which is characteristic impedance in free space. Hence the amplitudes of E and H may not be at their maximum at the same time so that in the LF-range E and H have to be measured and evaluated separately..

Since E-field strength depends on the voltage and the distance it is measured in volts per meter (V/m). The strength of the magnetic field which is current dependent is measured in amperes per meter (A/m). When taking into account the magnetic properties (magnetic permeability μ) of the propagation medium the magnetic field (H) is defined as the magnetic induction field ($B = \mu H$) and measured in tesla (SI units) or a subunit such as the microtesla (μT) or millitesla (mT).

Exposure guidelines

Though many safety and product standards for protecting workers and the general public against EMF have been published over the past decades the present guidance summarises only the ICNIRP guidelines and statement for the static and time varying EMF's on the one hand and the European directive 2004/40/EC for workers on the other hand.

➤ **ICNIRP (1994) guideline.**

Deals with the protection against static magnetic fields. It is the fundament of the Directive 2004/40/EC for the occupational action value of the magnetic induction field (B-field) for frequencies below 1 Hz. Note that the action values of the directive are the same as the reference levels used by ICNIRP. The reference levels used for testing the compliance of the measured static B-field are:

⇒ 200 mT working day averaged whole body exposure. The current density by moving in this field is estimated between 10 – 100 mA/m²

⇒ 2 T instantaneous whole body limit

⇒ 5 T instantaneous limit for limbs

Notice that the natural static magnetic field generated by the dynamo effect of earth varies between 30 and 70 μT .

➤ **ICNIRP (1998) guideline**

Deals with the protection of the general public and workers against time varying EMF's up to 300 GHz. A distinction is made between basic restrictions and reference levels.

▪ **Basic restrictions for LF EMF's**

Are based on the current density (J) induced in the body.. J is a calculation metric which is based on an established health effect.

In the ELF range 100 mA m⁻² is considered as the threshold current density limit for acute changes in the central nervous system excitability and other acute effects such as reversal of the visually evoked potential. . Based on the precautionary principle a safety factor of 10 is used so that occupational fields up to 1 kHz should be limited to fields that induce a J less than 10 mA m⁻².

Basic restrictions for frequencies between < 1 Hz and 100 kHz	
Frequency range	Current density for head and trunk J (mA m ⁻²) (rms)
Up to 1 Hz	40
1 – 4 Hz	40/f
4 – 1000 Hz	10
1 kHz – 100 kHz	f/100 (f in Hz)

▪ **Reference levels**

Are measurements metrics which are provided for comparison with measured values for compliance testing. If reference levels are exceeded the body induced current density has to be calculated and compared with the basic restriction limits. If the reference values are exceeded it doesn't necessarily mean that the basic restriction is exceeded.

Reference levels for frequencies between 0 Hz and 65 kHz			
Frequency range	E-field (V/m)	H-field (A/m)	B-field (μT)
0 – 1 Hz		1.63 10 ⁵	2 10 ⁵
1 – 8 Hz	20 000	1.63 10 ⁵ /f ²	2 10 ⁵ /f ²
8 – 25 Hz	20 000	2 10 ⁴ /f	2.5 10 ⁴ /f ²
0,025 – 0,82 kHz	500/f	20/f	25/f
0,82 – 2,5 kHz	610	24.4	30.7
2,5 – 65 kHz	610	24.4	30.7

ICNIRP statement (2003)

In the frequency range up to 100 kHz there are a number of EMF-sources (EAS, metal detectors, demagnetizers, welding equipment) with complex non-sinusoidal magnetic field wave forms which

exceed the ICNIRP (1998) limits. ICNIRP clarified this problem by providing guidance values and cut-off frequencies related to the basic restrictions for the current density and the electric and magnetic induction fields respectively.

➤ Directive 2004/40/EC

This directive deals with the minimum health and safety requirements regarding the exposure of workers to the risks arising from physical agents (electromagnetic fields). The directive only concerns workplace exposures and uses the same limit values as the ICNIRP guidelines. However, the basic restrictions of ICNIRP correspond to the exposure limit values of the directive and the reference levels of ICNIRP correspond to the action values of the directive. The implementation of the directive by the different member states of the EC is postponed till 2012.

Good measurement practice

There are a lot of static and ELF EMF sources situated in different workplace situations. They have different dimensions varying from small magnetic reactivators up to very big arc oven installations for metal melting. Moreover, the wave form, the frequency, the harmonic content, the polarisation and the general electrical parameters of the sources may be quite different. Very important in the exposure assessment is the characterization of the:

- Source: electrical parameters, dimension, positioning
- Field: magnitude, frequency, harmonics, waveform, polarization
- Waveform: sinusoidal fields or not, transient, time rate of change of B (dB/dt)
- Uncertainty & variability

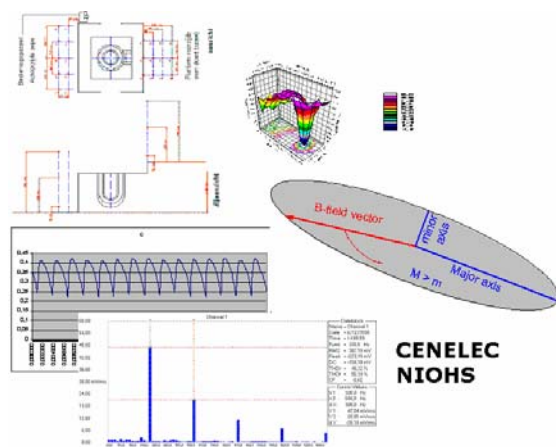

Good EMF measurement practice is a multi-step concept. It starts by mastering the basic physics for field characterisation and should be based on a balanced experimental design related to approved CENELEC standards and NIOHS manuals. Moreover it will have to take into account variability and uncertainty caused by a panoply of factors.

An obvious and important aspect in GMP is the consult with the safety staff about the exposure problem, the measurement objectives and the job content of the workers in terms of exposure position and duration. In order to define the complexity of the measurement situation, GMP requires a careful inspection of the working environment. A list of the relevant sources, their EMF characteristics and their orientation with respect to the workers or adjacent offices is indispensable. If the waveform and the harmonic content are unknown they have to be defined by oscilloscopic and spectrum analyses respectively. Compliance of unperturbed single frequency fields without substantial harmonics can be measured by broadband equipment and be tested regarding to the ICNIRP (1998) formulas for single frequencies. However, if one is faced to several sources emitting different frequency fields or to a single source emitting a substantial amount of harmonics selective measurements have to be performed and hence compliance testing is based on multi-frequency exposure approach. GMP becomes still more complex if complex pulsed non-sinusoidal waveforms are part of the exposure game. In such cases advanced oscilloscopic techniques and spectrum analyses have to be combined. A crucial point of such a combination is that the oscilloscopic harmonic content doesn't always fit with the one observed by spectrometry. Anyway, reasons have to be found, repeated measurements have to be performed for exposure reality and compliance testing with standards or guidelines for complex exposure situation. By performing GMP one always has to keep in mind that variability and uncertainty are a part of each measurement scenario. Though variability is a property of nature related to value heterogeneity over time, space and subjects and uncertainty is a lack of knowledge about the true value of exposure due to measurement errors or other factors, repeated measurement for defining the degree of reproducibility can bring some insight in both variables.

Measurement equipment

As shown in the next figure, there are different instruments needed for performing EMF measurements in the low frequency range.



Measurement equipment often used in occupational exposure assessment

The commercial instruments shown in the figure cover the frequency range from 0 Hz – 400 kHz. They also make it possible to measure the wave form as well as the harmonic content of the field under test. Since the electric and magnetic fields have to be measured and evaluated separately some meters are equipped with exchangeable probes for E and H fields while in others both sensors are integrated in the same probe. Moreover, low frequency spectrometer blocks contain selectable E- and H-spans covering a frequency range from 5 Hz up to 100 kHz. Other instruments contain a weighted frequency response so that the magnetic induction field can be displayed as a wide band value or as a percentage of the reference level of a selected exposure limit guideline. More specifications about these instruments can be found on the website of the instrument dealers.

Industrial High LF Exposure sources

The EMF sources this chapter is dealing with range from 0 Hz up to 20 kHz. Strictly speaking, they consist of a mixture of static, ELF and IF field sources and are therefore better defined as low frequency than as ELF sources. The following sources are discussed:

- Electrical electrolysis (0 Hz)
- Arc oven (50 Hz)
- Induction ovens (300 Hz – 10 kHz)
- Arc welding (DC, AC, DC-ripple)
- Spot welding (50 Hz – 20 kHz)



Sample of occupational LF sources

Electrical installation for electrolysis

When an electrical DC current is passing a liquid solution electrolysis by which chemically bonded elements or compounds are separated occurs.

In manufactures this process is used in big installations which may cover a relatively big area.

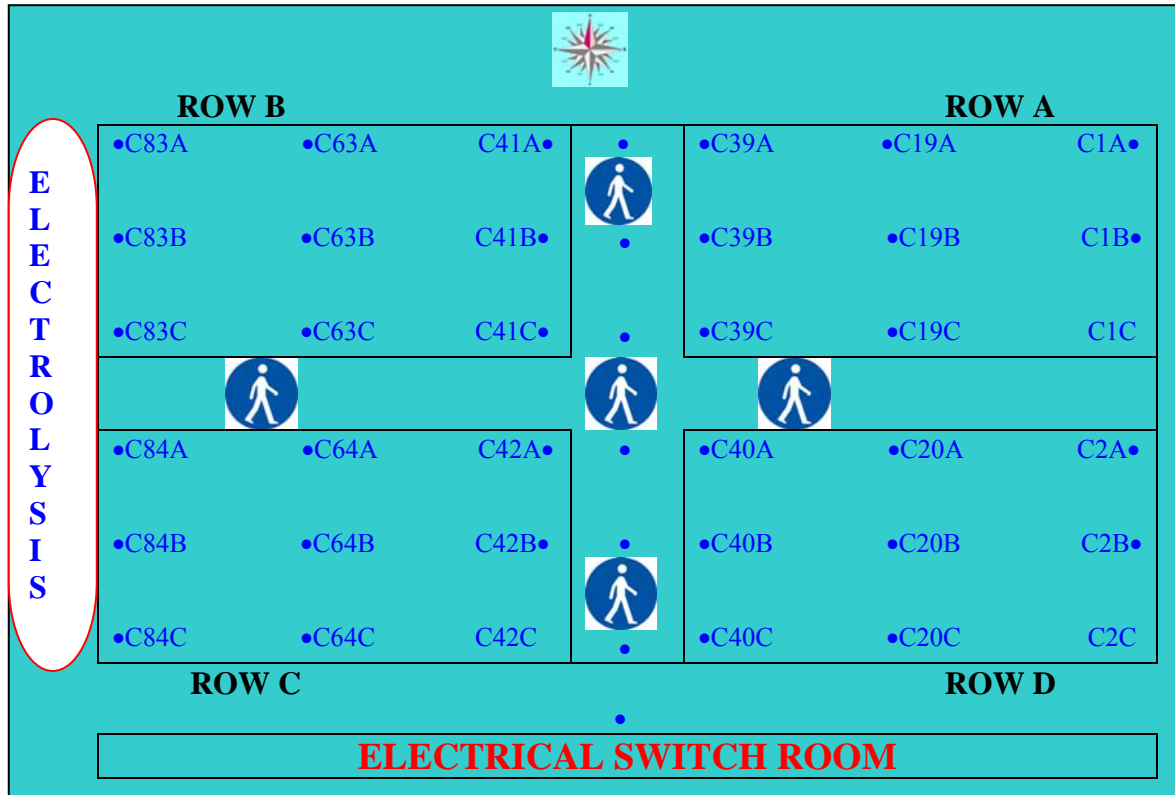

Ground plan of an electrolysis area with one measurement point per electrolysis cell

Since industrial electrolysis requires high DC currents (up to about 130 kA), workers might be exposed to a relatively strong static magnetic

induction field which can vary from one electrolysis cell to the other with a factor 5.

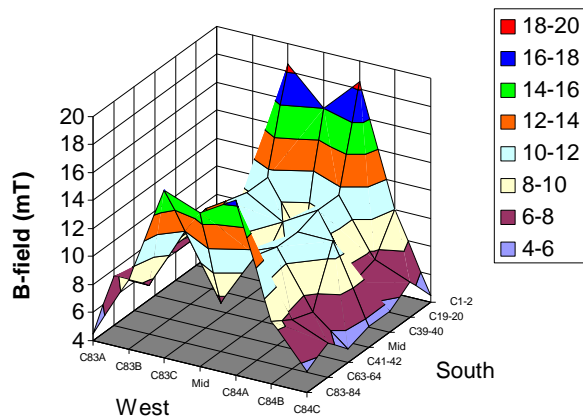

Static B-field (mT) distribution over the electrolysis area

Operators of the electrolysis unit may be exposed to a DC B-field gradient varying from 4 to 20 mT. If the induced current density by moving in a DC B-field of 200 mT is estimated to be 10 – 100 mA/m², a simple calculation tells us then that the induced current in the operator's moving in 20 mT (worst case exposure) electrolysis unit varies from 1 to 10 mA/m². It is compliant with the 40 mA/m² basis restriction limit for head and trunk of ICNIRP (1998) and the exposure limit values of the directive 2004/40/EC. On the basis of the interpretation of these exposure limits no direct health effect is to be expected for workers of electrolysis installations. However, this statement has to be interpreted with precaution because there still is a lack on representative measurement data which can be used as input data for performing reliable dosimetrical calculations about induced

current density by workers of industrial electrolysis installation..

As for the possible indirect effect which may occur at a 5 mT threshold level, it is recommended that carriers of pacemakers and other electronic devices know that levels of 0.425 mT and average levels of 0.352 mT may be encountered.

Notice that this paragraph only deals with the static field exposure of industrial electrical electrolysis installations and not with medical (e.g. MRI), pharmaceutical/biochemical (NMR-spectroscopy) or other occupational static field applications.

Electric arc furnaces

Most modern electrical arc furnaces (EAF) convert solid raw materials to liquid crude steel and refine it further in subsequent secondary steelmaking processes.

The EMF exposure assessment of the EAF we are dealing with is an ultra high power (AC) 96 MW furnace operating at 50 Hz for the production of liquid steel. The two following pictures illustrate show the heart and the outside (switch room side) of an EAF from which the EMF's were also measured.



Switch room side of a arc furnace

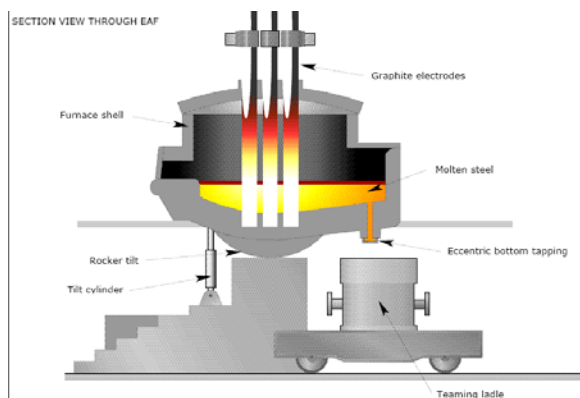

Heart of arc furnace

The exposure assessment of the B-field from big installations requires a good planning, prospection and measurement design by which instantaneous point measurements and field registration over a certain time can be performed respectively.

The next figure illustrates the ground plan and the measurement design of a switch room besides the arc furnace.

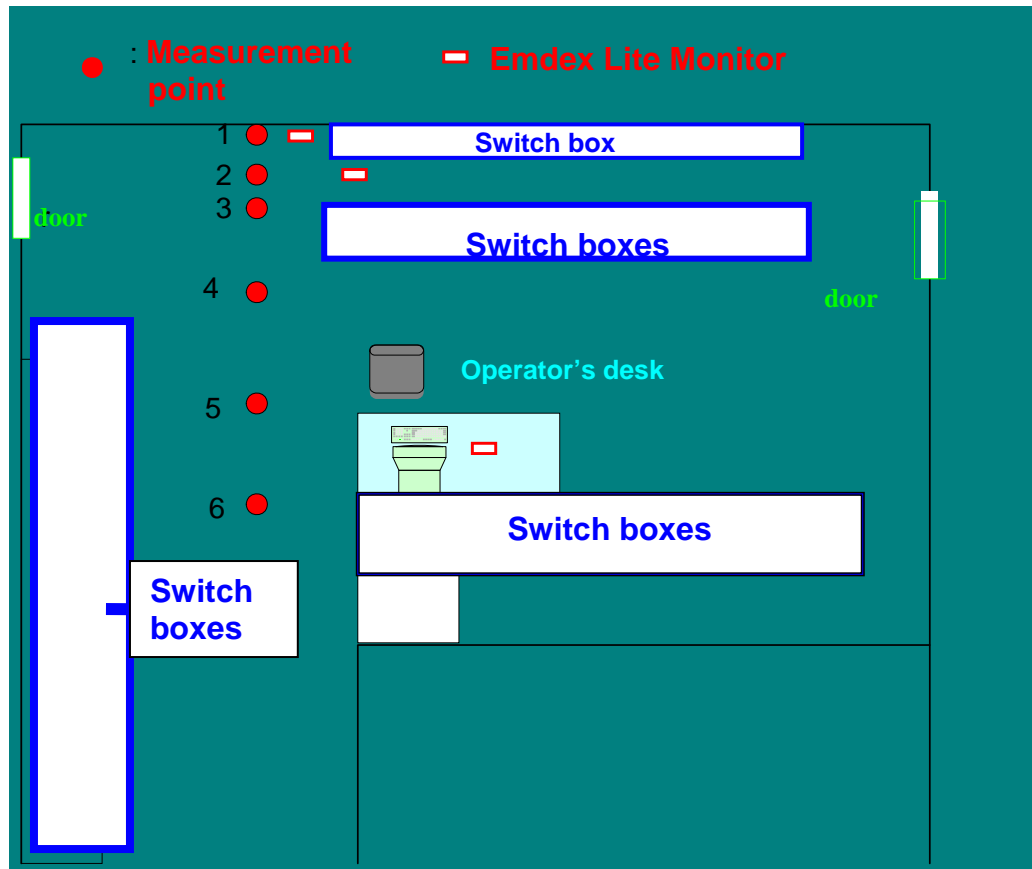

Ground plan of a switch room and measurement design

The next figure illustrates the current load of the installation per phase .

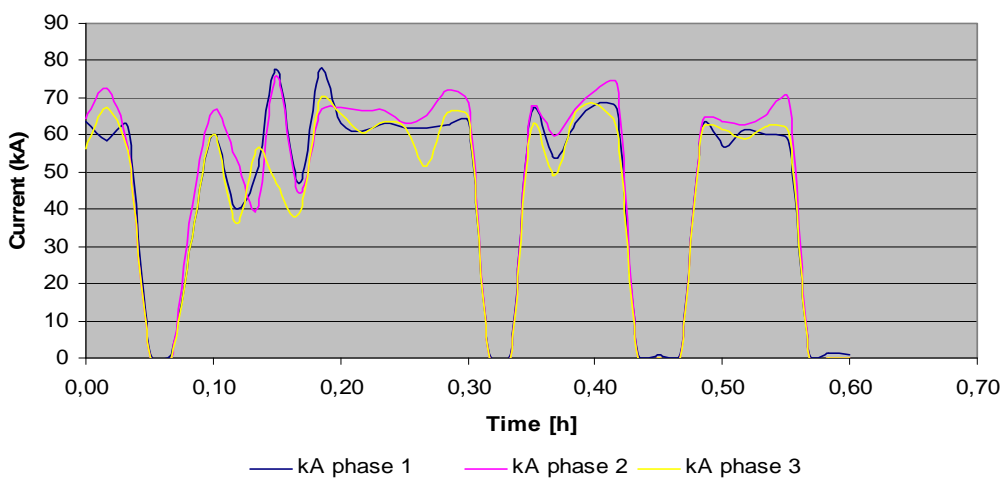

Current load versus time

Then the wave form and the harmonic content have to be checked

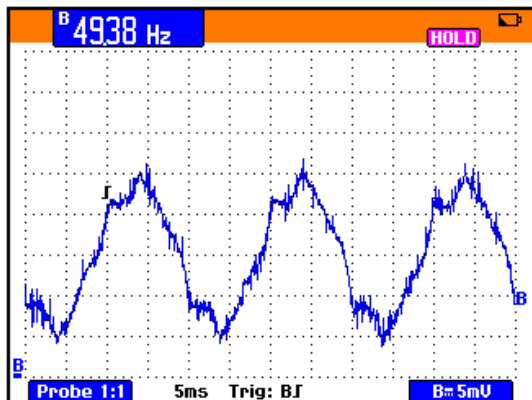

Wave form

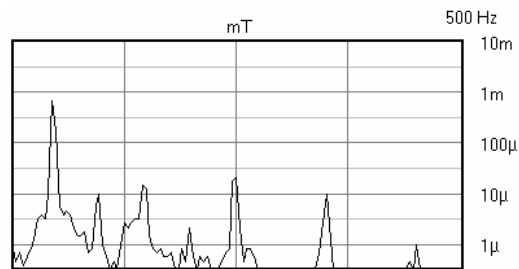

Harmonic content

Since the wave form is sinusoidal and no harmonics above 1000 Hz are present a first view of the 3 D exposure of the installation can be obtained by means of the EMDEX II meter fixed on a linear data acquisition (LINDA) wheel (Eneritech Ltd).

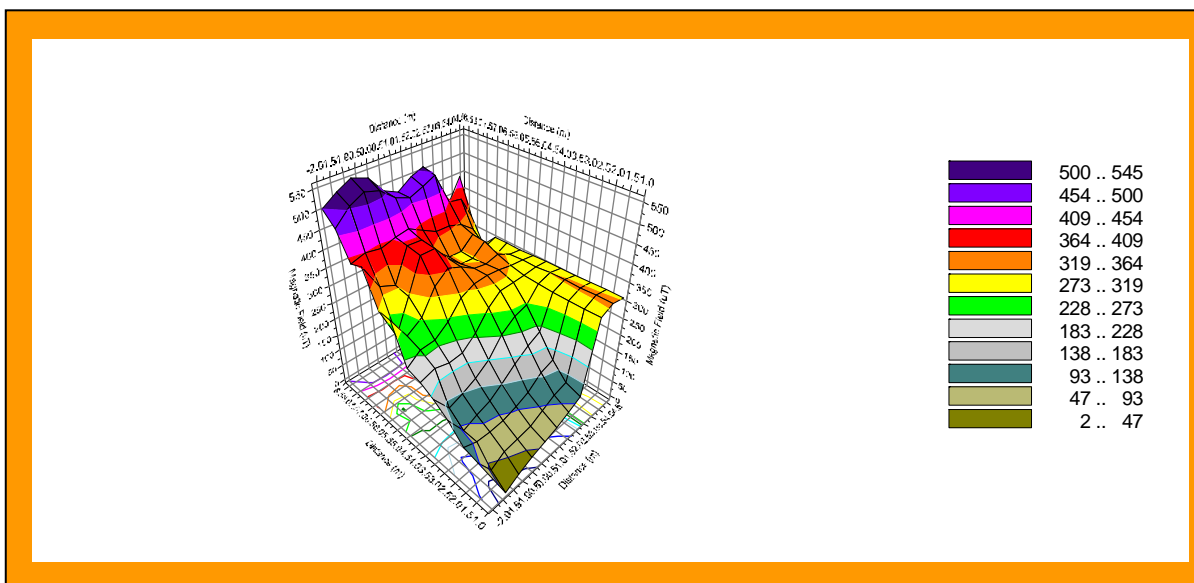

3 D map of B-field (μT) of arc oven installation

In order to get insight in the real B-field strength in space and time on the one hand and in the real exposure of the operators on the other hand place

dependent and personal dependent field registration can be performed respectively.

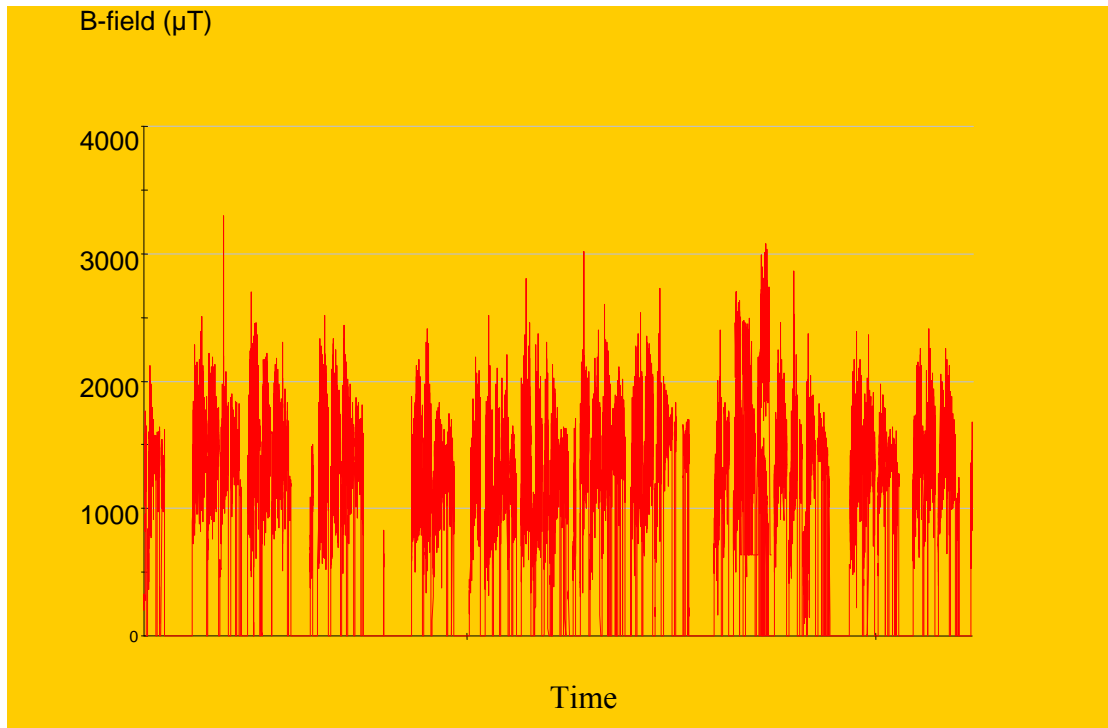

Example of B-field versus time in a point in space of the switch room

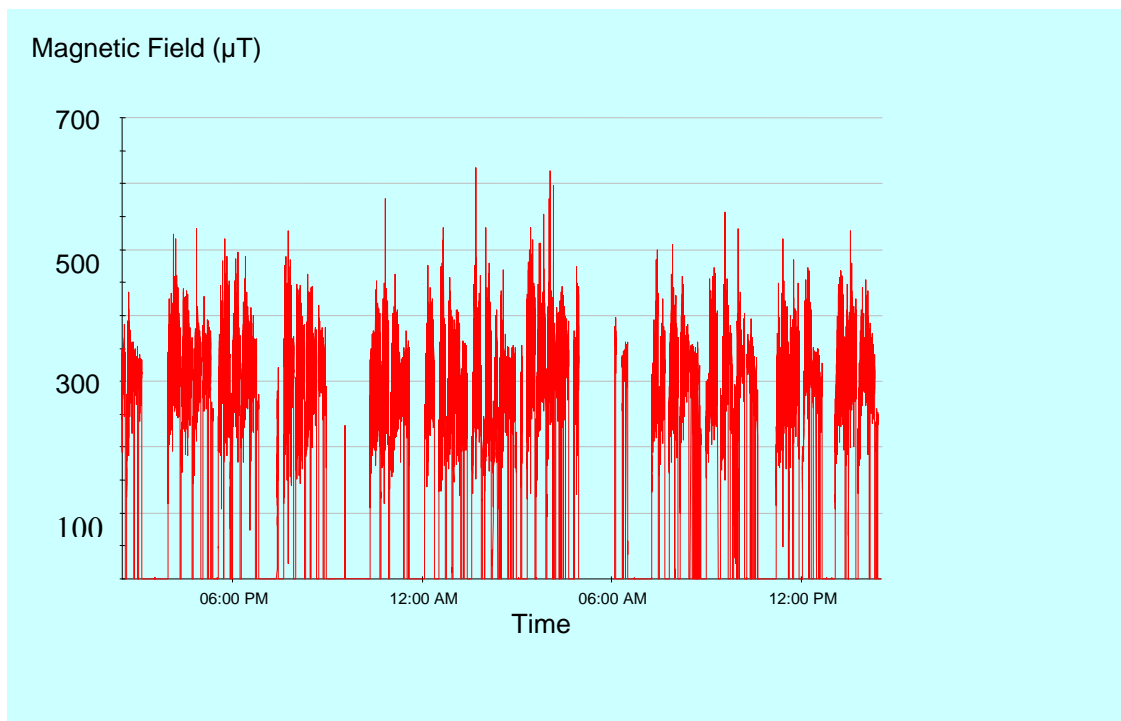

Personal exposimetry of the operator at the desk near the switch box

As shown in the next picture we have to check carefully the areas where important exposure levels can occur such as in the switch rooms of the understations of the arc furnaces. The next figure illustrates the area in a switch room near the furnace where the B-field level exceeds the 0.5 mT

reference level/action value. Hence compliance with the basic restrictions /exposure limit values have to be verified by comparing the calculated B-field induced current density with the limit value of 10 mA/m² in head and trunk.

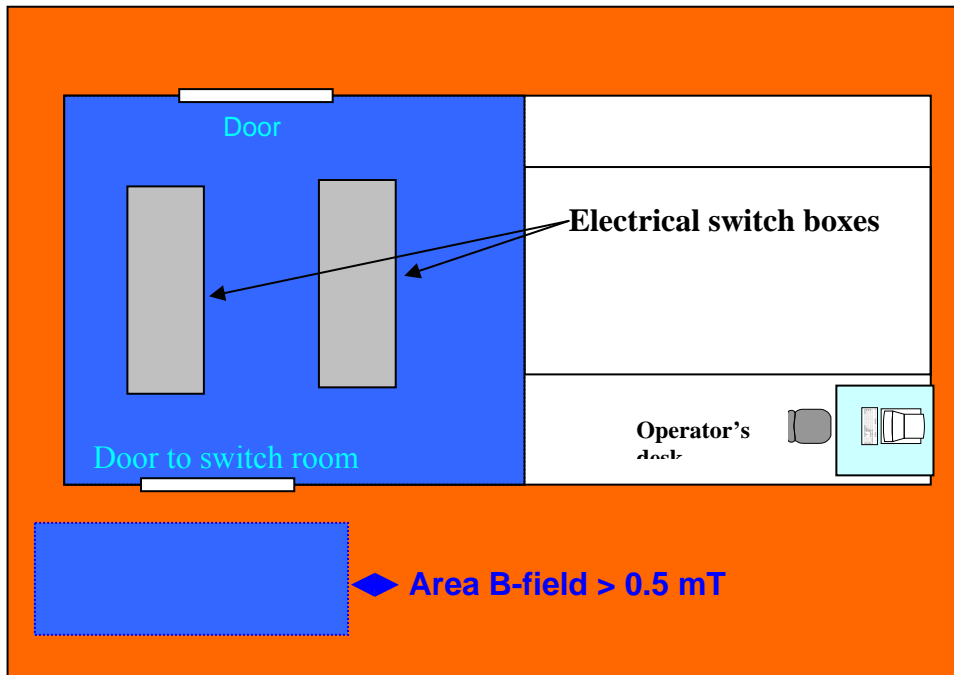

B-field in switch room of arc oven

The maximum B-field we observed in the arc furnace installation was about 5 mT. On the MT-2 workshop on calculation in Kielce (2007) it was concluded that the results obtained by the simplified ICNIRP (1998) formula ($J = \pi R f \sigma B$) were not substantially different from those calculated by means of complex dosimetrical models. Therefore we used this simplified approach to verify if a 50 Hz B-field of 5 mT induced a J that is compliant with the 10 mA/m² limit value.

As shown in the illustration the calculation was made in the worst case situation assuming a homogeneous 50 Hz B-field incidence of 5 mT in horizontal plan, a current loop circumference in the trunk of 1 m and a conductivity $\sigma = 0.2$ S/m

Under this worst condition a maximum current density of 2.5 mA/m² was induced in the trunk and strictly speaking no (expensive) protection measures (passive or active mitigation) have to be taken by the managing safety staff of the arc furnace installation. However as long as we have no solid quantified statistical data about the goodness or lack of fit between the results of sophisticated dosimetrical models and simplified formulas the uncertainty pertains that we made the wrong decision by rejecting protection rules though this hypothesis had to be accepted or vice versa.

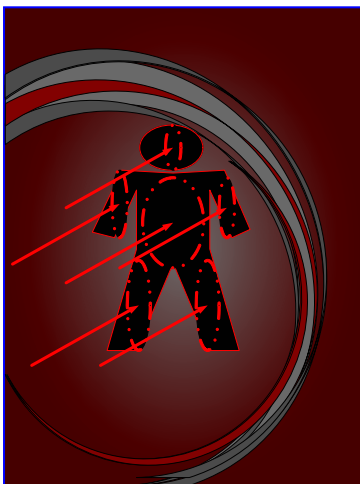

Worst case exposure

Notice that you can find many more approaches and details about calculation and dosimetrical techniques in the WP12 guidance made by P. Rossi. & R. Falsaperla. However, the arc furnace case gave the opportunity to illustrate the whole multi-step exposure assessment methodology that starts with an optimal experimental design and ends with calculations/models leading to decision rules about the worker's protection. The application of these rules might or might not be expensive: expensive if an older furnace installation has to be replaced by a

new one because neither the active nor passive mitigation can be performed.

Induction ovens for metal melting

The basic components of an induction oven are the power supply, the induction coils (usually made of copper) and the working unit which contains the load/material to be treated. When an alternating current is sent from the power supply to the induction coils a magnetic field inducing Eddy currents into the load is produced.

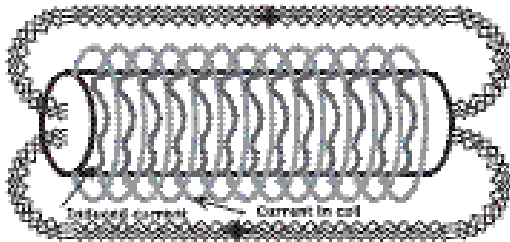

Due to the resistive reaction forces of the load against the electrical flow localized heat is produced in the load to be treated. Low frequency applications mostly use rectified power supplies. Mid- to high-frequency applications convert the AC to DC and then to higher frequencies. The frequency used depends on the material to be heated and the depth of penetration necessary for heating. Low frequencies are usually used for thicker materials and deep penetration. Higher frequencies are used for small parts or shallow penetration.

Exposure assessment

Induction ovens (often called induction heaters) are used for a great diversity of purposes. Anyway those on which the guidance is based are used for melting of Silver (S), Gold (G), Waste (W) and Steel (S). Their nominal power ranges from 200 to 2600 W and the operating frequency was 300 Hz (S), 3 kHz (G), 9 kHz (G), 1 kHz (W), 500 Hz (S) and 1 kHz (S). A detailed ground plan of the oven and its installation area is indispensable for efficient and reliable EMF exposure assessment of the operator and adjacent working offices.

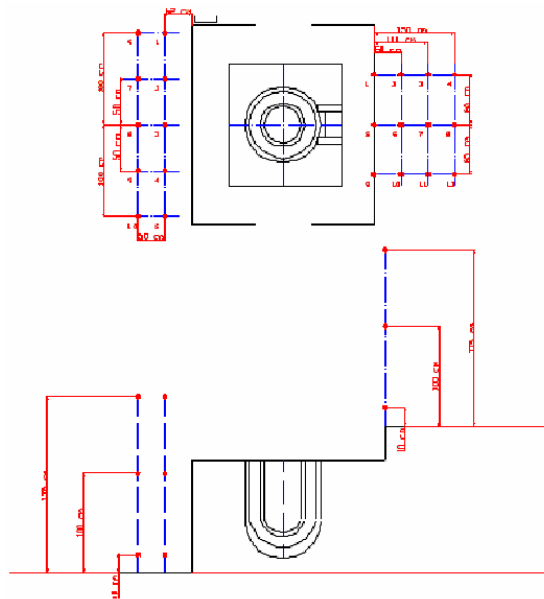

Ground plan of an induction oven with measurement grid around the oven

In order to have an idea of the average total body exposure we recommend to measure the B-field at different heights (0.1, 1.0 and 1.75 m) in each point of the grid.

The following pictures illustrate the way the operators work at the induction ovens and how they can be exposed



Operator working at open metal induction heater



Operator working at a small closed gold melting oven

As for eventual passive mitigation purposes it is especially for small sized ovens important to know the field polarisation (X, Y, Z-vectors): which part of the body is strongest exposed and can passive mitigation be applied without losing working comfort/efficiency and/or oven performance

The next tables summarise the most important electrical oven parameters and exposure variables that have to be taken into account for the exposure assessment of induction ovens

Electrical parameters of induction ovens

Oven ID	Power		Frequency		Application
	Nominal	Operating	Nominal	Operating	
1	450	60%	300 Hz	300 Hz	Silver melting
2	800	90%	3 to 3,3 kHz	3 kHz	Gold melting
3	800	60%	3 to 10 kHz	9 kHz	Gold melting
4	200	90%	1 kHz	1 kHz	Waste melting
5	2600	?	500 Hz	500 Hz	Steel melting
6	1800	?	1 kHz	1 kHz	Steel melting

This next table shows that most induction ovens operate irregularly, that the daily exposure duration varies from three quarters of an hour to 1 hour and that the distance between the oven and the operator strongly varies from 10 to 150 cm. By measuring the polarisation fields (X and Y- are the horizontal and Z is the vertical field vector) we can deduct in

which plane the operator of the induction oven is predominantly exposed if the polarisation is not circular.

Exposure variables

Oven ID	Melting Frequency	Operator's concern		B-field (μ T) and polarization			
		Exposure time (min)	Distance from oven (cm)	RMS	X%	Y%	Z%
1	Irregular	60	30	20	6	85	9
2	Irregular	60	30	107	7	51	43
3	Irregular	60	20	35	4	47	49
4	Irregular	45	10	309	44	39	17
5	Continue	45	150	60	20	70	10
6	Continue	60	60	29	8	87	5

Since the Y-vector represents the exposure in the horizontal plane between the oven and the operator the chest and abdomen are more exposed than the head and the hips. When the operator is going farther away from the oven the polarization becomes more circular and the exposure becomes

the same in the horizontal and vertical plane. The next figure shows the comparison between the observed B-field and the frequency corresponding the ICNIRP reference levels at operator's working distance.

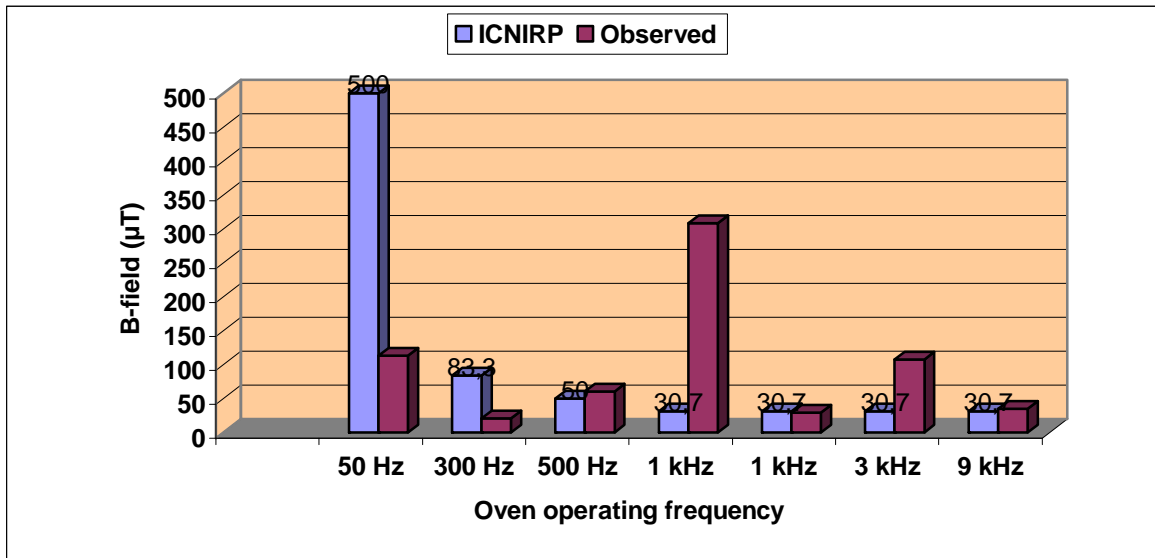

Observed B-fields at operator distance versus ICNIRP (199) reference levels

At an operating frequency of 50 Hz the B-field strength starts to exceed the ICNIRP(1998) reference level. It shows on the one hand that interference about compliance is frequency dependant and for ovens with a frequency of 500 Hz the induced current density for compliance testing with basic restrictions has to be calculated. By extrapolating the calculation protocol of the arc furnace to the induction ovens we found a 10 mA/m² induced current at operator distance by an induction oven operating at a frequency of 757 Hz and generating a B-field of 1360 µT. On base of these findings and since the induction oven was an of older type one it was decided that it should be

replaced by a new oven fitting the compliance requirements. Follow-up measurements performed by an independent body will verify this hypothesis.

The summarised results have shown that the B-field at normal operator position:

- often exceeds the reference levels/action values
- might exceed the basic restrictions/exposure limit values

Hence the induction ovens require a follow up on base of a good exposure design

Arc and Spot Welding



Arc welding machine

Though welding dates back to the bronze age where it was more an art than a technology nowadays it has become an important engineering science and business covering almost all industrial applications. It is a process of fusing two materials together using high current loads, heat, pressure and fillers. The reason why this document dealing with the exposure assessment of the EMF's of welding equipment is that welding demands high current loads which are



Spot welding machine

associated with high magnetic induction fields (B-fields) welders and adjacent workers might be exposed to.

Though there are many welding processes the two welding types that are predominantly applied are Arc welding and Gas Arc welding for what about electrical arc welding and different frequency

depending processes for what spot welding is concerned. The exposure assessment treated in the present guidance is therefore based on the most important arc and spot welding processes respectively. The next table summarizes the welding processes which are used in the present guidance for the EMF exposure assessment of welders.

Widely used industrial welding processes

Welding processes	Current type		
	AC	DC	DC puls
Gas Metal Arc Welding (GMAW) also called MIG/MAG	-	++	+
Shielded metal arc welding (SMAW)	+	++	-
Gas Tungsten Arc Welding (GTAW) also called TIG	+	+	+
Submerged Welding (SAW)	+	++	-
Resistance Spot Welding	++	+	-

++: mostly used; + : less or equally used; - : not used

(source Belgian EMF welding report 2008)

Gas Metal Arc Welding (GMAW) is frequently referred to as MIG welding. MIG welding is a commonly used high deposition rate welding process. Wire is continuously fed from a spool. MIG welding is therefore referred to as a semiautomatic welding process. (source AMC)

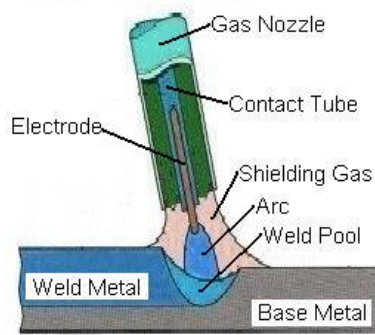

Gas Tungsten Arc Welding (GTAW) is frequently referred to as TIG welding. TIG welding is a commonly used high quality welding process. TIG welding has become a popular choice of welding processes when high quality, precision welding is required.

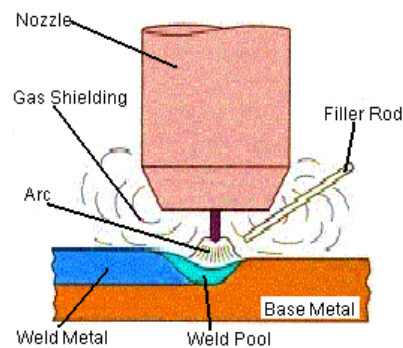

Submerged arc welding (SAW) is a process in which the welding actually occurs while submerged under a layer of flux. The flux prevents oxygen from entering the weld and thus prevents porosity in the weld.



Shielded metal arc welding (SMAW), is a manual arc welding that uses a consumable electrode coated in flux to lay the weld. An alternating or direct current from a welding power supply, is used to form an electric arc between the electrode and the metals to be joined.



Resistance Spot Welding (RSW), Resistance Seam Welding (RSEW), and Projection Welding (PW) are commonly used resistance welding processes. Resistance welding uses the application of electric current and mechanical pressure to create a weld between two pieces of metal. Weld electrodes conduct the electric current to the two pieces of metal as they are forged together.

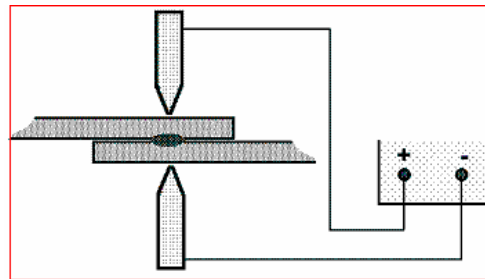

Welding Process Statistics

In order to get statistics on industrial welding processes an inventory about this issue is indispensable. It is the fundament of an optimal

measurement design. Next table summarises the results of such an inventory for arc welding processes made in big Belgian enterprises.

Welding process	ABT (%)	Current Type	Mean % of use	Current load [A]	Mean % of use
Gas Metal Arc Welding (GMAW) Solid wire	25	DC+	60	150 – 250	47
		Pulse	40	250 – 350	43
				> 350	10
(GMAW) Flux cord arc welding (FCAW)	30	DC+	88	< 150	10
		DC-	12	150 250	57
				250 – 350	33
				> 350	1
Shielded Metal Arc Welding (SMAW)	20	DC+	71	50 – 100	25
		DC-	28	100 – 150	37
		AC	1	150 – 200	24
				> 200	13
Gas Tungsten Arc Welding (GTAW) or TIG	25	DC-	99	< 50	5
		AC	1	50 – 100	30
				100 – 150	50
				150 – 200	14
		> 200	1		

^a Arc burning time: average burning time in percentage of the whole welding time (source: Belgian EMF welding report 2008)

Welding measurement processing

The next flow chart shows the different steps that have to be followed for performing exposure

assessment and compliance testing related to welding.

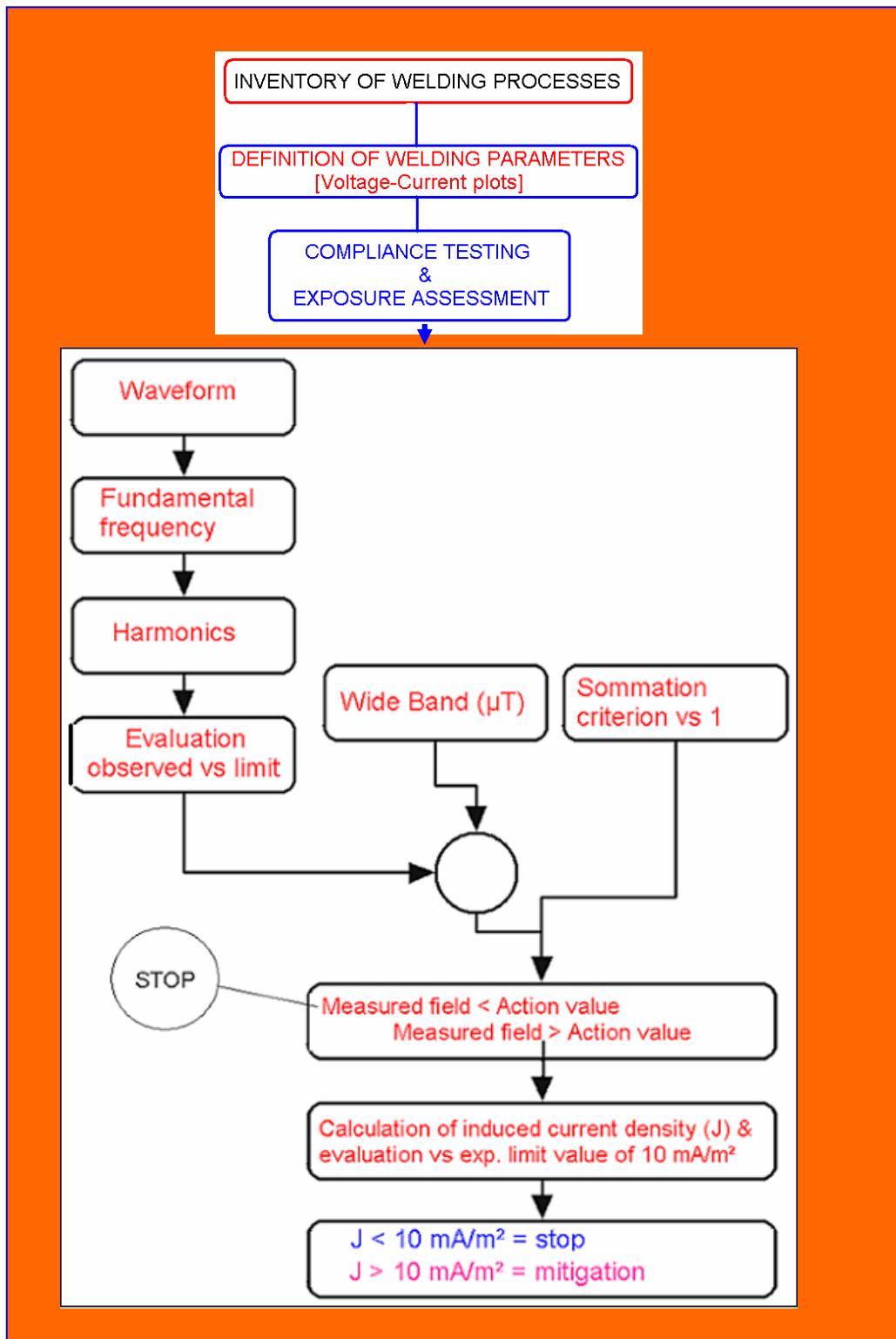

Arc welding

An electric arc is an electrical breakdown of a gas which produces an ongoing plasma discharge, resulting from a current flowing through normally nonconductive media such as air.

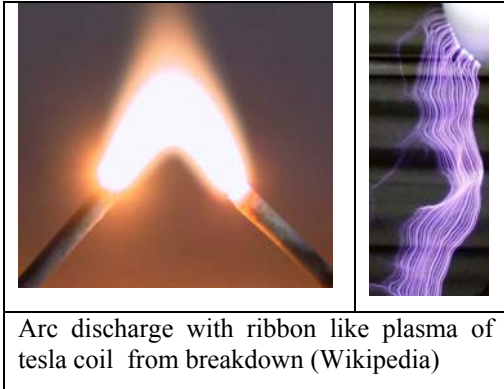

Arc discharge with ribbon like plasma of tesla coil from breakdown (Wikipedia)

▪ How can we define the current waveform?

A shunt is fixed at the current path of the welding machine.



Welding machine with shunt and current clamps

After the current clamps are fixed on the cable the waveform can be measured by means of special current designed oscilloscopes (ALX and HKS).



Scopes for measuring the voltage- current waveform

▪ How can we do compliance testing and exposure assessment

By compliance testing we think in terms of the EMF emission of the welding equipment (control panel, cable, torch) at a certain point in space. By exposure assessment we think in terms of the field strength received by the worker's body and the possible risks.

As for the EMF compliance testing of arc welding attention will only be paid to measurements of the welding cable. In this respect it is advised to measure the magnetic induction field (B-field) according to the protocol of the CENELEC standards prEN 50444 and 50445 of September 2006. Despite this advise, the big gap in terms of exposure assessment is that the only point of investigation (POI) for testing compliance is at a distance of 20 cm between the probe tip and the bent cable and that the contact between cable and the worker's body has not been taken into account. Anyway this doesn't exclude that the magnitude of the B-field can be measured at other POI's for evaluating the possible associated risks.

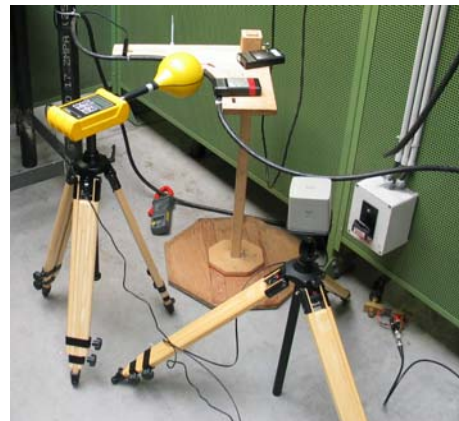

Setup for measuring the B-field of the cable

Moreover, one should also be interested in the B-field level at 10 cm from the cable.

The next figure illustrates how the B-field strength generated by the cable can be measured at body level by means of point measurements covering a frequency up to 400 kHz. Notice that if the frequency and the harmonic contents of the generated field fit with the measurement requirements of the personal monitor (sinusoidal wave form and frequency within 40 Hz – 1000 Hz) those measurements also can be made by personal exposimetry.



B-field measurement on the welder's body

- Sinusoidal/triangular which may be continuous or pulsed fields: they are characterized by their frequency
- Non-sinusoidal waveforms where the frequency range exceeds the nominal frequency. In this case the rise and decay time, pulse duration, and repetition rate are best defined
- Transients which may contain substantial amounts of energy can be observed too.

The waveform and harmonics can be measured by means of the ELT 400 meter connected to a FLUKE-scope.

▪ **Waveform and harmonics of the magnetic field**

Since many different arc welding processes exist the waveform, frequency and harmonic components may be quite different so that it is essential to define these parameters. This is required for selecting the adequate exposure guideline/standard to which the measured B-field should be compared for decision about compliance and health risks respectively. In summary, the waveforms that may be observed in the welding practice are:

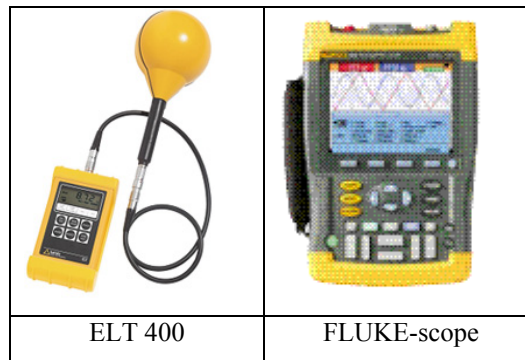

Result processing

This chapter will give some relevant examples to illustrate the complexity behind the interpretation of the welding parameters, the compliance testing and

exposure assessment of welding equipment and welders respectively

Waveform and Harmonics

➤ MIG semi-automatic short-cut welding

The figures 1 to 6 show the waveforms and the harmonics from short cut welding obtained with two different welding machines. The frequency of the voltage, current and magnetic fields is

determined by the number of short-cuts that occur per second. By each short-cut a voltage drop and a current rise simultaneously occur (figures 1 and 4)

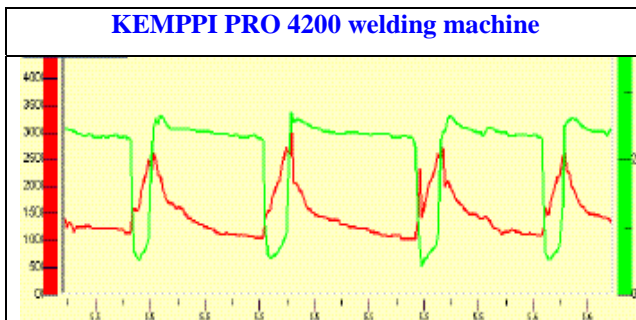

Figure 1: Voltage (green) and current (red) waveform

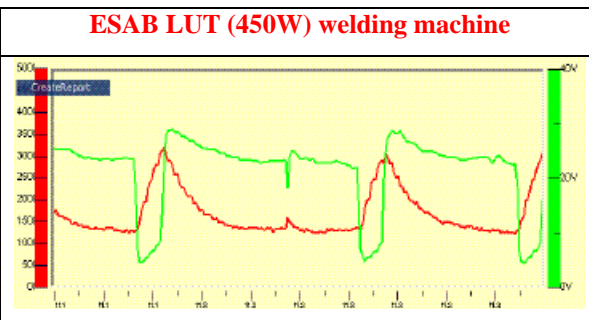

Figure 4: Voltage (green) and current (red) waveform

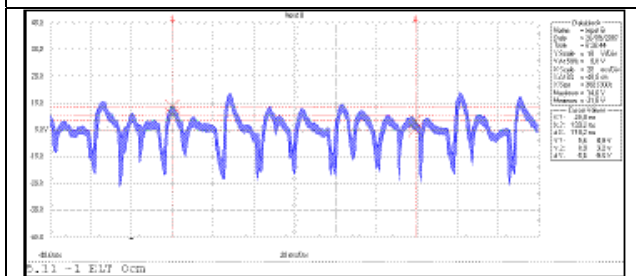

Figure 2: Waveform of magnetic field

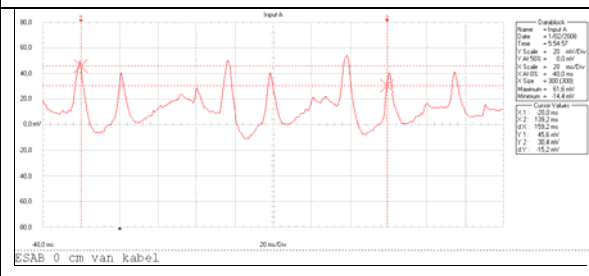

Figure 5: Waveform of magnetic field

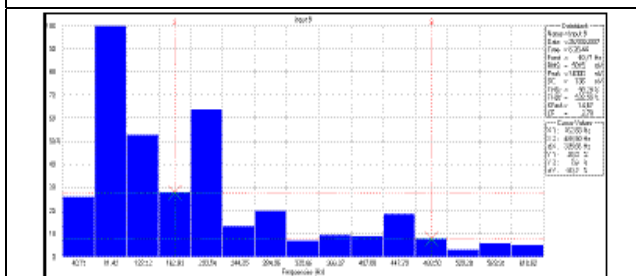

Figure 3: Harmonics with fundamental frequency of 81.42 Hz

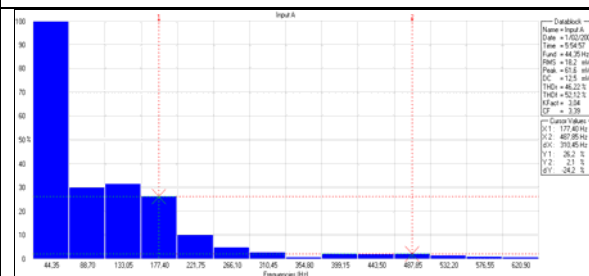

Figure 6: Harmonics with fundamental frequency of 44.35 Hz

(source Belgium EMF welding report 2008)

This series of figures shows that though both welding machines generate similar waveform

shapes, the fundamental frequency obtained with the Kemppi machine (81.42 Hz) is nearly double

the one obtained with the ESAB (44.35 Hz). Moreover the harmonic content from the Kemppe is quite different from the ESAB. These differences may imply that though wide band B-field measured at both machines may be the same with respect to

the action value, the result of the summation formula based on the harmonics may lead to contradictory conclusions about compliance. This point will be further clarified in the section about measured fields.

➤ Pulsed short cut welding with low and high current parameters

The figures 7 to 9 show the waveforms and the harmonics obtained by the low current pulse welding process. The figures 10 to 12 show the voltage-current waveform and the waveform of the magnetic field and its harmonic content obtained

by high current pulse welding process. The shape of the waveforms is similar but the frequency and the harmonic contents are quite different for the two processes.

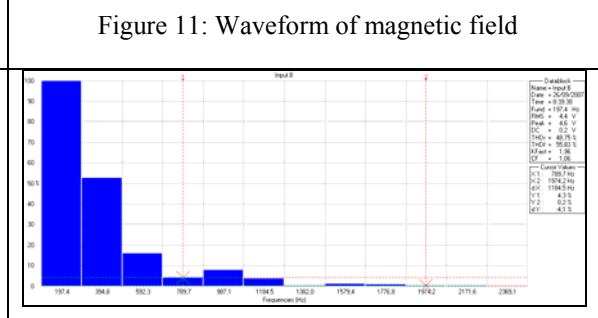
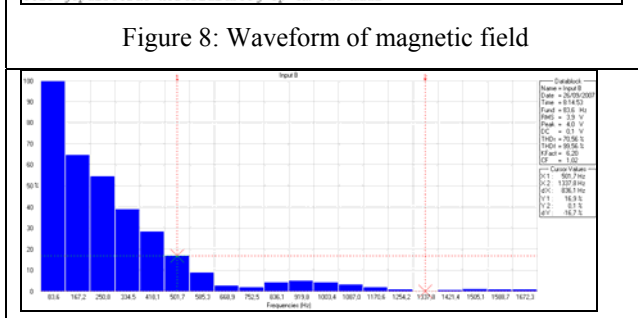
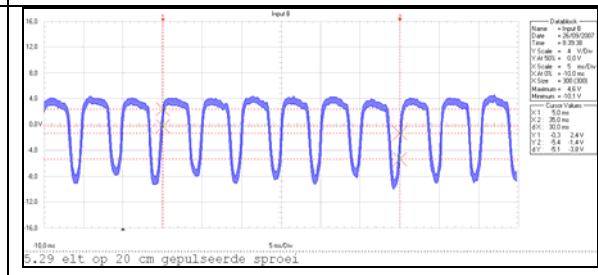
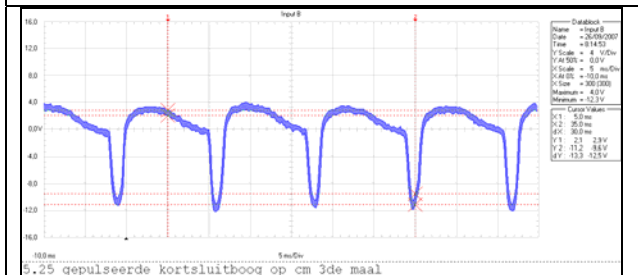
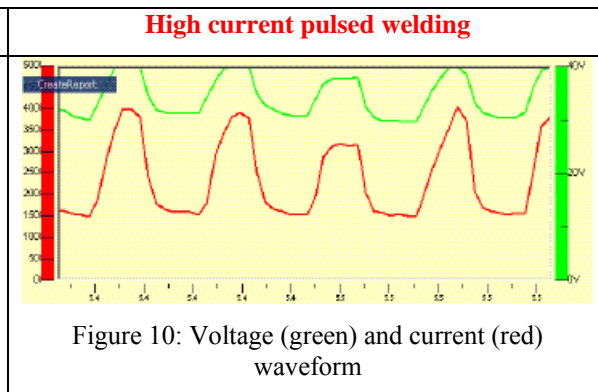
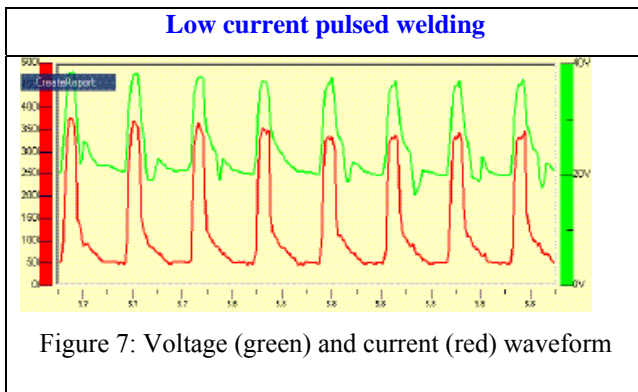

(source Belgium EMF welding report 2008)

➤ AC shielded metal arc welding (SMAW) and DC Gas Tungsten Arc Welding (GTAW or TIG)

The figures 13 to 15 show the waveforms and the harmonics from the AC SMAW welding process. The wave form of the B-field is block shaped with a fundamental frequency of 60.1 Hz. The figures 16-18 show the waveforms and harmonic of the DC

TIG process where a quasi sinusoidal waveform with a fundamental frequency of 156.3 Hz was found.

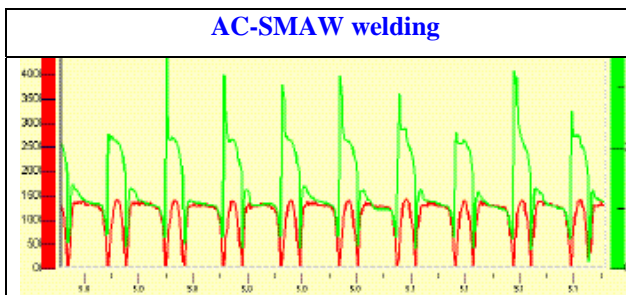

Figure 13: Voltage (green) and current (red) waveform

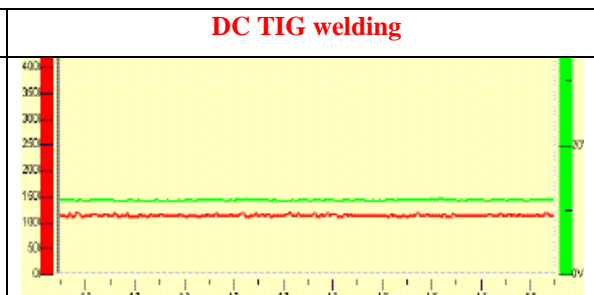

Figure 16: Voltage (green) and current (red) waveform

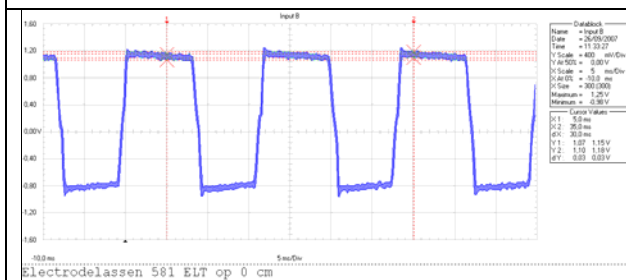

Figure 14: Waveform of magnetic field

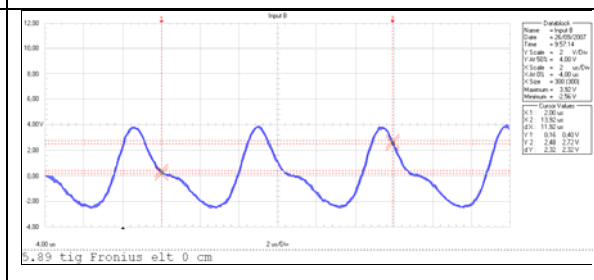

Figure 17: Waveform of magnetic field

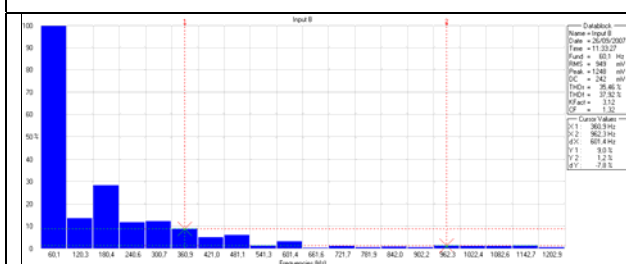

Figure 15: Harmonics with fundamental frequency of 60.1 Hz

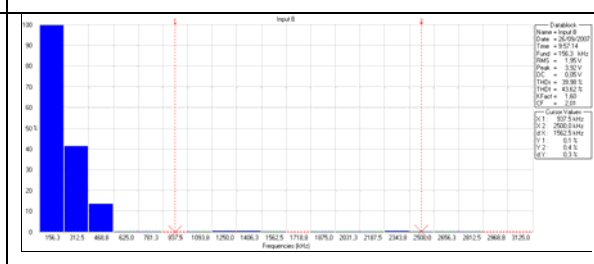

Figure 18: Harmonics with fundamental frequency of 156.3 Hz

(source Belgium EMF welding report 2008)

The aim of showing this series of waveforms and harmonics in the framework of this guidance is to illustrate that almost every welding process is characterized with its typical current and field parameters which might substantially vary according to different welding processes and even within the same processes when different equipment is used. This chapter clearly shows that

compliance testing and exposure assessment of arc welding is a multi-complex process where a lot of attention has to be paid to all the steps associated with the measurement event.

Measured fields

On the basis of the next table (extract of the Belgian EMF welding report) we will illustrate the complexity that may arise by comparing the measured B-field strengths with the action values/reference level for interferences about compliance testing and exposure assessment. Next

table shows only the measurement results made round the cable in agreement with the CENELEC protocol. Notice that the B-field was measured with the ELT 400 in the wide band mode and in the percentage of the action value (AV) mode. Both measurements were made in exactly the same welding and measurement conditions. The bold red italic values in the table indicate no compliance with the action values or reference levels.

Welding machine	Current type	Process	Fund. freq. & Action Value	Distance to cable [cm]	B-field measured in the mode of :	
					Wide band [μ T]	% of AV
Kemppi pro 4200	DC+	Short cut	81 Hz (AV 309)	0	172	<i>1150</i>
				10	106	<i>653</i>
				20	60	<i>427</i>
		Low current pulsed short cut	84 Hz (AV 298)	0	<i>310</i>	<i>895</i>
				10	161	<i>501</i>
				20	108	<i>343</i>
		High current pulsed short cut	198 (AV 126)	0	<i>350</i>	<i>913</i>
				10	196	<i>475</i>
				20	125	<i>307</i>
ESAB LUD 450W	DC+	Short cut	45 Hz (AV 555)	0	171	<i>521</i>
				10	90	<i>206</i>
				20	60	<i>169</i>
		Low current pulsed	83 Hz (AV 301)	0	<i>561</i>	<i>1315</i>
				10	285	<i>620</i>
				20	199	<i>169</i>

(source Belgian EMF welding report 2008)

What do the results tell us about recommendations?

Inspection of the table shows three phenomena which are important in the framework of this guidance:

1. at 20 cm from the cable (CENELEC distance) there is never an agreement about compliance between the data measured in the wide band and in the percentage to AV mode: when the wide band measured B-field is compared with the corresponding action value there is always compliance whereas compliance is never found when the measurement are made in the percentage of the AV mode.
2. when other distances from the cable than 20 cm are considered the data of the two measurement modes agree only in 1 on 5 cases when the measurements are

performed on the cable ($d = 0$) and in none of the 15 cases at 10 cm from the cable

3. the B-field measured on the cable ($d = 0$) is always between 2 and 3 times stronger than the one at the 20 cm distance recommended by CENELEC.

By these contradictions the following questions arise:

- which of both measurement methods leads to reality or in other words is the body responding to the wide band exposure or to the sum of the harmonics which form the base of the percentage to AV mode or the summation formula.
- what's the rationality behind the recommendation to test compliance at 20 cm from the cable and not on the cable while certain parts of the body are predominantly in contact with the cable.

Hence, the following recommendations are justified in the framework of this guidance for arc welders:

- look for a best available welding technique for avoiding contact between the cable and the body: the best adviser in this case is the experience of the welder
- in the framework of the precautionary principle the discussion about the distance from the cable for compliance testing has to be re-opened in terms of the cable/body contact which is perhaps difficult to avoid without loss of welding comfort and/or efficiency

Spot welding

It is a type of resistance welding used to weld various sheet metals typically of about 0.5-3.0 mm thick. The process uses two shaped copper alloy electrodes to concentrate welding current and force between the materials to be welded. The result is a small "spot" that is quickly heated to the melting point, this forms a nugget of welded metal after the current is removed. The amount of heat released in the spot is determined by the amplitude and duration of the current. The current and duration are chosen to match the material, the sheet thickness and type of electrodes.

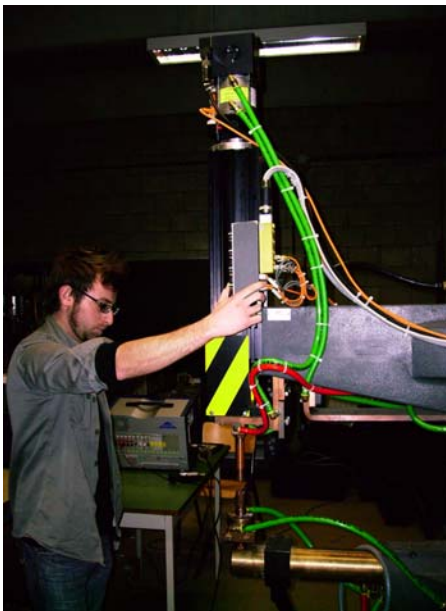

Normal operator position during spot welding

How to measure the magnetic field?

The spot welding machines we experienced with are an/a:

- AWL 65 kVA 50 Hz machine
- ARO 180 kVA MFDC 1 kHz machine

- the problem about the contradiction in measurement readings leading to different conclusions about compliance has to be solved. Anyway, as long as the results of both methods do not agree we cannot decide whether the B-fields generated by arc welding processes are compliant with the action values or not.

- Matuschek 32 kVA HFDC 20 kHz table model

It is advised that the B-field is measured in a 3 axis plane while the position of the probe in a angle of 0°, 45°, 90° with respect to the electrode of the machine. The 0° is the reference axis which is the axis in front of the electrode. In each axis the B-field is measured on a height of 0.20, 1.00 and 0.75 m. Moreover each axis is divided in a doubling radial distance starting from 5 cm from the electrode up to 1 m. In each point the measurements were performed in the wide band and the percentage of the action value mode of the ELF400.

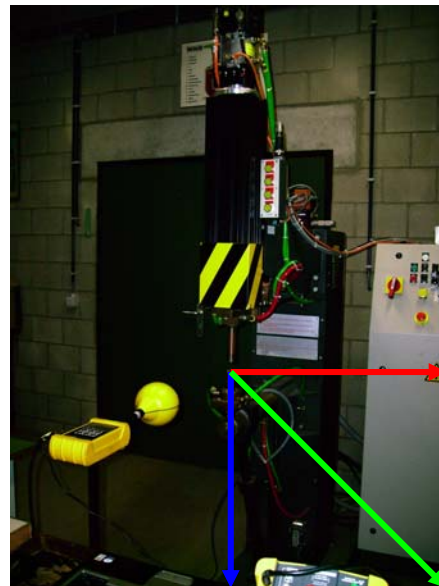

3 axis probe position (0° blue, 45° green, 90° red)

The measurement equipment that may be advised is a/an:

- DEWETRON scope for defining the current parameters of the machine
- ELT 400 for measuring the B-field
- FLUKE scope for defining the waveform and the harmonics of the B-field

Result processing

Waveforms and harmonics

The figures 1 to 7 show how waveforms and harmonics of three different spot welding machines look like. For the AWL and ARO machine the measured fundamental frequency agreed with the nominal. The waveform of the Matuschek was too unstable for taking the waveform and the harmonics

of the field. Therefore the nominal 20 kHz frequency will be used for calculating the action value for comparing the measured fields.

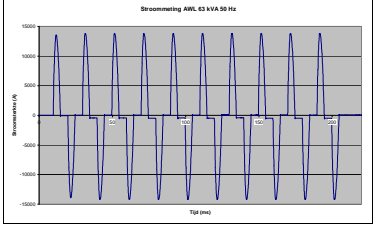
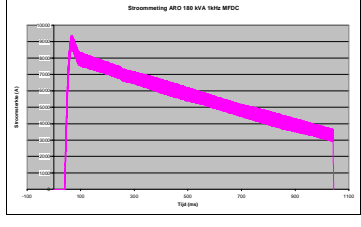
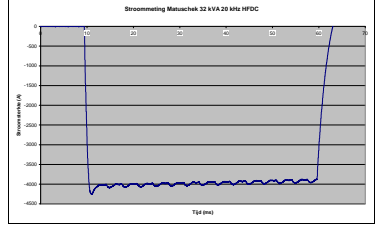
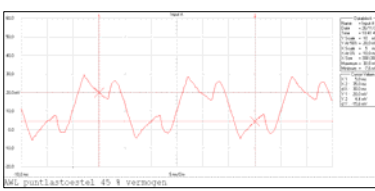
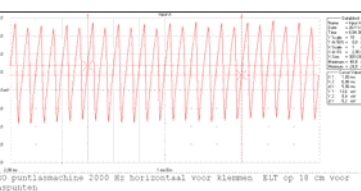
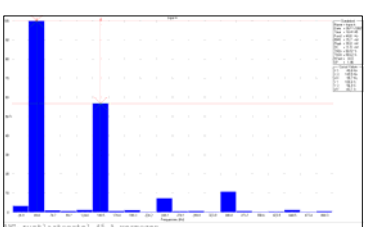
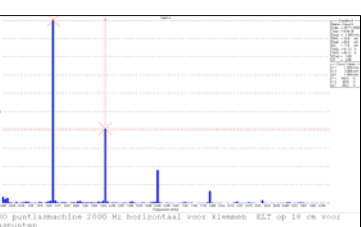
AWL 65 kVA	ARO 180 kVA MFDC 1kHz	Matuschek 32 kVA HFDC 20 kHz
 <p>Figure 1: Current waveform</p>	 <p>Figure 4: Current plot</p>	 <p>Figure 7: Current plot</p>
 <p>Figure 2: Waveform of B-field</p>	 <p>Figure 5: Waveform of B-field</p>	<p>Waveform too unstable to take picture</p>
 <p>Figure 3: Harmonics</p>	 <p>Figure 6: Harmonics</p>	<p>Waveform too unstable to take picture</p>

(source Belgium EMF welding report 2008)

Measured fields

In the next two tables an example is given of the results measured on different heights and different radial distances from the electrode of a 50 Hz spot welding machine ($P = 45\%$ and $I = 7.9$ kA). The

tables summarises the results made at the 3 heights in the 3 axis plane ($0^\circ, 45^\circ, 90^\circ$)

The measurement height of 109 cm corresponds to the vertical position of the electrode of the machine.

Table 1: Measurements made in the percentage of the action value mode

Distance to electrode [cm]	Measurement Position	Percentage of action value				
	Angle of measurement axe $[\circ] \rightarrow$	0			45	90
	Measurement height [cm] \rightarrow	20	109	175	109	109
5	Action value is 500 μ T	0,69	1766	110	overload	overload
10		0,6	670	91	overload	1867
20		0,44	192	58	1197	544
40		0,32	82	38	341	222
60		/	44	/	145	/
80		/	27	/	79	/

(source Belgian EMF welding report 2008)

Table 2: Measurements made in the wide band mode

Distance to electrode [cm]	Measurement Position	Wide band B-field [μ T]				
	Angle of measurement axe $[\circ] \rightarrow$	0°			45°	90°
	Measurement height [cm] \rightarrow	20	109	175	109	109
5	Action value is 500 μ T	42	2371	/	overload	overload
10		39	1211	58	1827	3151
20		33	450	50	785	1277
40		24	119	33	237	331
60		17	49	22	111	126
80		/	25	/	48	/
100		/	15	/	/	/

(source Belgian EMF welding report 2008)

The results of the tables show that the B-field strength is different at different heights and axes respectively. Therefore it is recommended to perform the measurements at different heights and in different axes.

If we consider the percentage of the action value mode (table 1) at a height of 109 cm of the 45° axis we see that the B-field strength is not compliant within a distance of 60 cm from the electrode.

However if we consider the same measurement in the wide band mode this distance corresponds only to 20 cm. This agrees with the contradiction between both measurement modes we already observed with arc welding. In this respect the recommendations for the spot welding are the same of these made for arc welding.

Portable spot welding

Portable spot welding (PSW) is a type of resistance welding where high currents are used and consequently strong magnetic fields may be produced. PSW is mainly used in SME's and in a less extend in big industries for welding metal sheets.



PSW and ELT 4000

Result processing

The PSW generates a pure 50 Hz sinusoidal field without harmonics so that the measured wide band B-field can simply be compared with the action value for compliance testing.

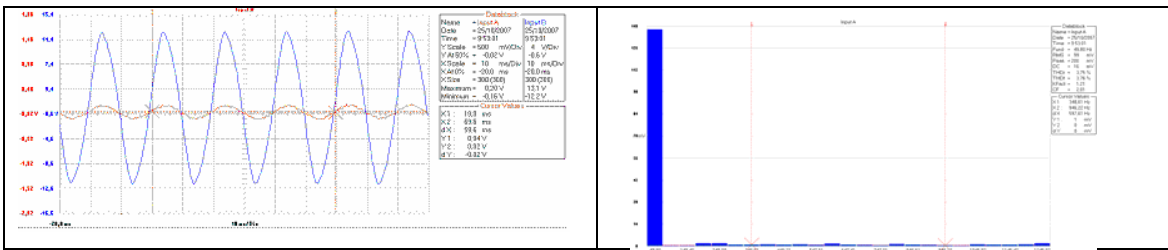

The next table shows the results where the approach was focused on reproducibility of the results within the same PSW-device. Notice that for the present guidance we only are interested to know the measurement variability within one

PSW device but that we don't want to know variability within and between different PSW devices for interferences and decisions about the B-field of the PSW population.

Distance to electrode (cm)	M1			M2			M3		
	Mean B-field (μT)	Stdev	N	Mean B-field (μT)	Stdev	N	Mean B-field (μT)	Stdev	N
1	1045	54	6	921	61	6	1531	43	6
10	216	6	6	213	13	6	230	21	6
20	66	5	6	73	3	6	74	2	6
30	31	1	6	31	1	6	32	1	6
40	16	0	6	16	0	6	16	0	6
50	10	0,3	6	10	0,4	6	9	0,5	6

- M1: measurement in horizontal direction in front of contact point during spot welding
- M2: measurement in vertical direction above contact point during spot welding
- M3: measurement in vertical direction under contact point during spot welding

Measurement methods

The measurements the guidance is dealing with were made on a TECNA model (max 11 kVA and 7.4 kA) with a welding duration of 1.3 seconds.

It is recommended to measure the waveform, the harmonics and the B-field for PSW with the same equipment as done for the spot welding machines discussed in the chapter above. Moreover it is also advised to measure the B-field in a three axis' plan and since it is a portable system also on the body of the operator.

It shows that for testing reproducibility N repetitive measurements have to be made per measurement point in M planes. The results show that one has to be very close to the electrode to exceed the action value of 500 μT . However the most interesting and most important observation from the table is that the closer to the electrode the measurements are made the bigger the variability in terms of standard deviations from the mean B-fields. Though uncertainty is different from variability this observation implies that the uncertainty about a single point measurement made near to the electrode is much bigger than the one made at a point farther away from the electrode. Hence it is advised that compliance should not be tested on base of a single point measurement but that it should be based on representative location and dispersion statistic.

What can we tell about the B-field distribution on the body?

Since the next figure shows that the B-field on the different parts of the body agrees with the action value of 500 μT it is advised that operators of PSW devices choose the best welding position available by respecting more or less the distances indicated in the picture.

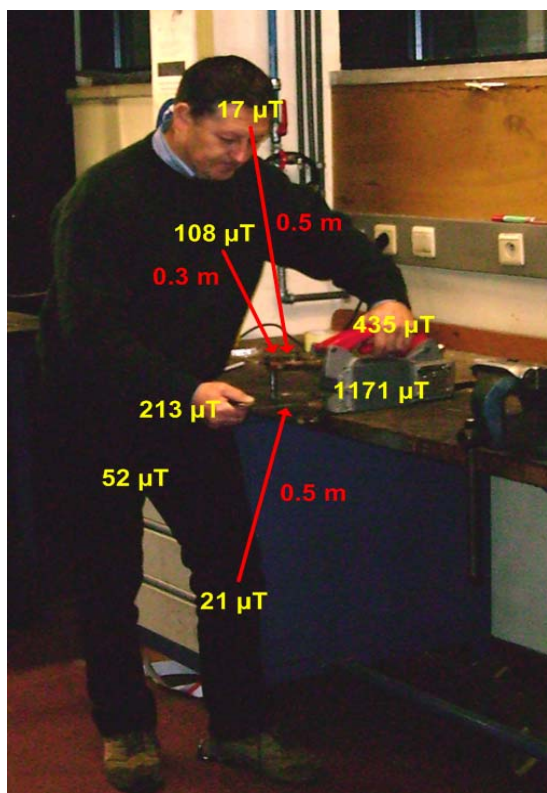

Distribution of the B-field over the body of the PSW operator

As for avoiding a possible indirect effect by interference with pacemakers and/or other electronic implants it is recommended that carriers of such implants do not use PSW devices since at a distance of 30 cm from the chest the 100 μT threshold for interference with old pacemakers is exceeded.

What can we recommend about welding in general?

Throughout the data we've shown that EMF compliance testing and exposure assessment of arc welding as well as spot welding are complex tasks. Therefore it is first of all recommended that an experienced staff is involved in the job. The staff must at least consist of :

- a welding engineer, knowing the great diversity of welding processes and related electrical welding parameters
- an EMF expert, knowing the physics, the measurement and exposure assessment techniques and the interpretation of guidelines and standards in terms of reproducibility, uncertainty and variability
- last but not least, an experienced technical staff with a perfect know how of the measurement equipment and how to deal with measurement artefacts or aberrations

Good communication between all members of the crew in every step of the measurement and reporting process is indispensable in order to get a qualitative and reliable final product. Although there is a tendency to put exposure assessment or compliance testing into the plants' own safety staff's hands we have to be aware that the complexity of this task is that great that the results delivered by an unexperienced person or group will be unreliable and has to be repeated by an experienced staff.

Because the measurements showed that welders are exposed to magnetic induction fields which exceed the action value by cable contact during arc welding and at operator's distance during spot welding on the one hand and the lack of modelling data and data on protection possibilities in the welding sector on the other hand it is recommended that:

1. reliable calculations/models for checking compliance of the body induced current with the exposure limit value/basic restriction will be applied to or developed for the welding sector
2. advanced research on active and passive mitigation possibilities which have certainly to be efficient for arc welding has

to be stimulated. Since the Biot-Savart rule for field attenuation with distance is hard if not possible to apply for arc welding developing LF magnetic field reducing protective clothing (that doesn't limit working comfort or welding efficiency) is perhaps the best solution here.

3. operators of spot welding machines could enlarge their distance to the electrode to at least 60 cm therefore research on efficient remote control systems for starting the spot welding machine measurement should be encouraged.

As for sensitive groups such as carriers of pacemakers and/or other electronic implants, pregnant women and youngsters in welding education we have the following advice.

Because of the risk on interference, carriers of pacemakers and/or other electronic implants do not weld with any system.

Since more and more women start to work as a welder in the industry or weld in art schools it is recommended on base of the precautionary principle that they don't weld when they are pregnant.

As for youngsters between 14 and 18 year who are in their welding education we roughly calculated that a youngster who is welding about 18 h a week receives the same amount of B-field in 12 days than a child that is permanently exposed to $0.4 \mu\text{T}$ by living under a power line. If there is an epidemiological relation between the $0.4 \mu\text{T}$ exposure by power lines for children between 0 and 15 years old and childhood leukaemia why should we not be prudent with youngsters who are, though not continuously, exposed to far higher B-field strengths when they are welding.

References

- Belgian EMF welding report 2008: Broeckx K; Decat G., Deckx L., Meynen G., Casteels M., Van Rymenant P., Mild K.H. Meten en evalueren van de blootstelling van lassers aan elektromagnetische velden in het kader van de nieuwe Europese EMF-richtlijn 2004/40/EC [[Evaluation of the EMF exposure of welders in the framework of the directive 2004/40/EC]. BIL/VITO 29/02/2008
- CENELEC prEN 50444, September 2006. Basic standard for the evaluation of human exposure to EMF from equipment for arc welding and allied processes.
- CENELEC prEN 50445 September 2006. Product family standard to demonstrate compliance of equipment for resistance welding, arc welding and allied processes with the basic restrictions related to human exposure to electromagnetic fields (0 Hz – 300 GHz).
- CENELEC prEN 50505 September 2006. Basic standard for the evaluation of human exposure to EMF from equipment for arc welding and allied processes.
- CENELEC EN 50499. 2006. Determination of workers exposure to electromagnetic fields.
- CENELEC EN 50392: 2004-01: Generic standard to demonstrate the compliance of electronic and electrical apparatus with the basic restrictions related to human exposure to electromagnetic fields (0 Hz – 300 GHz).
- CENELEC 2006. Basic standard on measurement and calculation procedures for human exposure to electric and magnetic and electromagnetic fields (0 Hz – 300 GHz). Draft pr EN 50413.
- Decat G., Decks L., Meynen G., Wilczek D. Is the use of simplified current density formulas reliable for testing compliance with exposure limit values? Proceedings: XIV Congress of the Polish Radiation Research Society memorial to Maria Skłodowska-Curie. September 24-26, 2007. Kielce, Poland.
- Directive 2004/40/EC of the European Parliament and of the Council of 29 April 2004 on the minimum health and safety requirements regarding the exposure of workers to the risks arising from physical agents (electromagnetic fields) (18th individual Directive within the meaning of Article 16(1) of Directive 89/391/EEC), O.J. nr L-184 of 24 May 2004.
- ICNIRP (1994) Guidelines on Limits on Exposure to Static Magnetic Fields. Health Physics, vol. 66, No. 1, 100-106; 1994.
- ICNIRP (1998) Guidelines for Limiting Exposure to Time-Varying Electric, Magnetic, and Electromagnetic Fields (up to 300 GHz), Health Physics, vol. 74, No. 4 (April), 494-522; 1998.
- ICNIRP (2003) Statement Guidance on determining compliance of exposure to pulsed and complex non-sinusoidal waveforms below 100 kHz with ICNIRP guidelines. Health Physics 84(3): 383-387; 2003.
- ICNIRP 13/2003, Exposure to Static and Low Frequency Electromagnetic Fields, Biological Effects and Health Consequences (0 – 100 kHz). Int. Commission on Non-Ionizing Radiation Protection 2003.
- NIOSH Manual for measuring occupational electric and magnetic field exposure. U.S. Department of Health and Human Services. Public Health Service. Centres for Disease Control and Prevention. National Institute for Occupational Safety and Health. DHHS (NIOSH) Publication No. 98-154.
- NIOSH/WHO Occupational EMF document. Evaluation and managing occupational exposure to EMF. A Joint Publication of the World Health Organization International EMF Project and the U.S. Centres for Disease Control and Prevention, National Institute for Occupational Safety and Health. In preparation.

An information publication from the EMF NET project

Author: Gilbert Decat ,

VITO – Mol – Belgium ,

Phone +32 (0) 14 33 59 41 000• <http://web.jrc.ec.europa.eu/emf-net/>

Graphic design and illustrations: Gilbert Decat



An information publication from the EMF NET project
SSPE-CT-2004-502173 EMF-NET MT2 working group
Effects of the Exposure to Electromagnetic Fields:
From Science to Public Health and Safer Workplace
Coordination Action 8. Policy Support and Anticipating
Scientific and Technological Needs



Occupational exposure fact sheet

Hand held Magnetic Reactivator

There are different kinds of RF- and ELF tag reactivation and deactivation systems for library purposes. The one this fact sheet is dealing with is a popular ELF hand held reactivator for activating the book tags in libraries.



The fundamental operating frequency of the device is 50/60 Hz and the power output 125 W.

This kind of reactivators allows the library staff to activate book tags in a fast and simple way

by taking the books on one arm while gliding the reactivator over the tag side of the books.



Though this method seems to be the fastest and most convenient for the operator, the disadvantage of it is that the chest of the operator may be exposed locally to strong magnetic induction fields, certainly when the

reactivator touches the operator's chest while activating the tags of the books.

In order to investigate the possible exposure the magnitude of the magnetic induction field (B-field) has to be measured at the four sides of the reactivator.

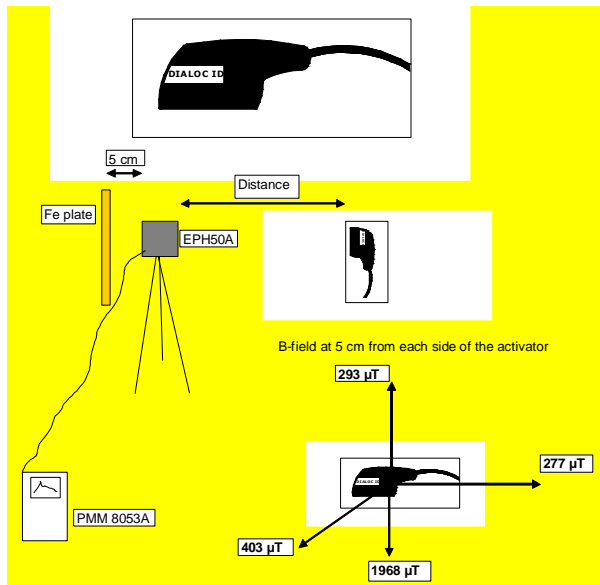

The B-field is especially high at the bottom side (± 21 mT on the bottom and 2 mT at 5 cm) of the device and moreover it generates a substantial amount of harmonics

EHP 50 22.05.06 14.46.55
Level: 20,55 mT (Wide Band)

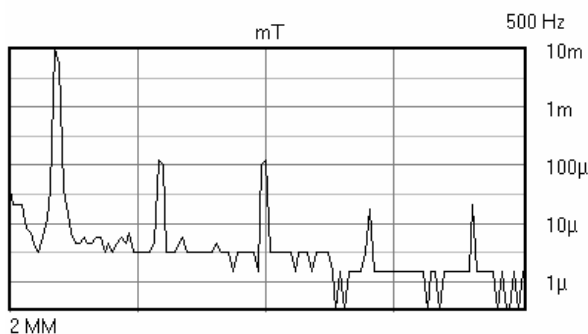

Because of the harmonic content, compliance with the reference limits has to be concluded on

base of the summation formula. Though no health effects have been associated with the activators, operators can however protect themselves against the high B-field exposure at chest's level by gliding the reactivator over the tag after the books are placed on the tabletop..



Passive mitigation for protecting the hand that holds the reactivator is not obvious and should if necessary be investigated on base of efficient shielding materials.

An information publication from the EMF NET project
Author: Gilbert Decat, VITO, Integrated Environmental Studies, Mol, Belgium
Phone +32 (0)14 33 59 41
<http://web.jrc.ec.europa.eu/emf-net/>.
Photo's: Gilbert Decat
Graphic design: Gilbert Decat



An information publication from the EMF NET project
SSPE-CT-2004-502173 EMF-NET
Effects of the Exposure to Electromagnetic Fields:
From Science to Public Health and Safer Workplace.
Coordination Action 8. Policy Support and
Anticipating Scientific and Technological Needs



Practical guidance for occupational EMF exposure assessment Numerical dosimetry

What is dosimetry of EMF?

Electromagnetic dosimetry treats the quantitative evaluation of the interaction between an electromagnetic field and an exposed subject. Since biological matter is characterized by the presence of electrical charges and currents, the action of the exposure results in induced currents and energy absorption.

Dosimetry is addressed to the study of such physical phenomena and to their quantitative evaluation by means of physical parameters, named dosimetric quantities, that are directly related to the biological effects. Such parameters are the induced current density J (frequencies up to 10 MHz), and the Specific Absorption Rate - SAR (frequency from 100 kHz to 10 GHz).

Induced current density J [A/m^2] is the current flowing per unit cross-sectional area inside an exposed body. Due to the inhomogeneity of the body, current density should be averaged over a cross-section of 1 cm^2 .

SAR [W/kg] is the EMF energy that is absorbed in the body tissues for unity of time and mass. SAR values are to be averaged over any 6-minutes period.

Current density. The current flowing through a unit cross section perpendicular to its direction in a volume conductor such as the human body or part of it, expressed in ampere per square meter ($A\cdot m^{-2}$). Current density is the dosimetric quantity used in the frequency range up to 10 MHz.

Specific energy absorption rate (SAR). The rate at which energy is absorbed in body tissues, expressed in watt per kilogram ($W\cdot kg^{-1}$). SAR is the dosimetric quantity that has been widely adopted at frequency above about 100 kHz.

The frequency of the field and the dielectric properties of the exposed subject are the parameters that mainly influence the physics of coupling mechanisms, and dielectric properties of biological systems, including human tissues, are described by two parameters, the electrical conductivity σ [S/m] and the relative electrical permittivity ϵ_r .

The protection from established effects of electromagnetic fields is based on the definition of basic exposure limits expressed in terms of dosimetric quantities. Such limit values, that cannot be exceeded in any condition of exposure, are provided by the ICNIRP Guidelines (ICNIRP, 1998), and enforced in the Council Recommendation 1999/519/EC on the limitation of exposure of the general public to EMF, and in the Directive 2004/40/EC on the protection of workers from exposure to EMF. Dosimetric quantities are set on the basis of the thresholds of biological effects, applying proper safety margins.

In the following table the ICNIRP basic restrictions for general public and occupational exposure are presented. In accordance with the ICNIRP philosophy, the safety margin for the workers is 10, being 50 for general public taking into account the presence of individuals particularly susceptible in the population.

Table 1. Basic restrictions for frequencies up to 10 GHz: Occupational exposure

Frequency range	Current density for head and trunk (mA·m ⁻²) (rms)	Whole-body average SAR (W·kg ⁻¹)	Localized SAR (head and trunk) (W·kg ⁻¹)	Localized SAR (limbs) (W·kg ⁻¹)
up to 1 Hz	40	-	-	-
1 – 4 Hz	40/f	-	-	-
4 Hz – 1 kHz	10	-	-	-
1 – 100 kHz	f/100	-	-	-
100 kHz – 10 MHz	f/100	0.4	10	20
10 MHz – 10 GHz	-	0.4	10	20

Table 2. Basic restrictions for frequencies up to 10 GHz: General public exposure

Frequency range	Current density for head and trunk (mA·m ⁻²) (rms)	Whole-body average SAR (W·kg ⁻¹)	Localized SAR (head and trunk) (W·kg ⁻¹)	Localized SAR (limbs) (W·kg ⁻¹)
up to 1 Hz	8	-	-	-
1 – 4 Hz	8/f	-	-	-
4 Hz – 1 kHz	2	-	-	-
1 – 100 kHz	f/500	-	-	-
100 kHz – 10 MHz	f/500	0.08	2	4
10 MHz – 10 GHz	-	0.08	2	4

Dosimetry plays an important role in the risk assessment process, but its function is of great concern also in laboratory studies addressed to investigate the effects of EMF on biological systems. In fact, as required by WHO, biological experiment must be carried out under known and controlled exposure conditions in order to ensure their repeatability. This implies, both for “*in vivo*” and “*in vitro*” studies, the need of dosimetric characterization, strictly related to EMF energy absorbed by the biological target.

Dosimetric evaluation can be based on experimental, analytical and numerical methods.

Use of experimental dosimetry

Experimental dosimetry is commonly used to evaluate SAR in the head produced by mobile phones, and for dosimetric characterization of biological material during in “*in vitro*” and “*in vivo*” studies.

It is based on measurement inside phantoms of current density and SAR by means of miniaturized electric field or temperature meters. Phantoms are made of biological-equivalent material able to simulate, at the frequency of interest, dielectric properties of the exposed biological material.

Even if the accuracy of such methods will be improved in the future, the use of experimental dosimetry is primarily addressed to the validation of numerical methods.



Example of experimental dosimetry set up (<http://www.ets-lindgren.com/>)

Use of analytical dosimetry

Analytical dosimetry is based on the direct mathematical solution of the exposure problem as described by Maxwell’s equations, taking into account the exposure conditions (sources and environment) and the properties of the exposed subject.

Due to the complexity of Maxwell’s equations, analytical dosimetry is applicable only to simple exposure scenario, and when the exposed subject can be represented by means of a simple geometrical solid (like a sphere, cylinder or ellipsoid), homogeneous from the point of view of dielectric properties, in free space or over an infinite, perfectly conducting ground plane.

Complex exposure scenarios, including realistic anatomical human models, cannot be solved by means of analytical dosimetry. In spite of these limitations, analytical dosimetry is useful for qualitative consideration and basic understanding of coupling phenomena. Analytical methods can be employed as a check for numerical techniques as well as experimental dosimetry.

Use of numerical dosimetry

Numerical approach consists of solving Maxwell's equations by means of computational methods, employing accurate models of dielectric properties of tissues. This approach is at the moment the most commonly used, due to its capability to simulate complex exposure scenarios and to evaluate induced current and SAR, as well as the internal electric field, in the exposed subject.

Numerical techniques adopt the following general approach:

- development of a set of differential or integral equations in order to model the electromagnetic problem (Maxwell's equations);
- representation of the exposure scenario, by means of a discrete model of the exposed subject, field source, and surrounding environment, made of small homogeneous elements (pixels in 2D problems, voxels in 3D problems);
- assignment of dielectric properties (frequency dependent) to each element;
- transformation of differential or integral equations into a set of algebraic ones;
- resolution by means of standard computational algorithms.

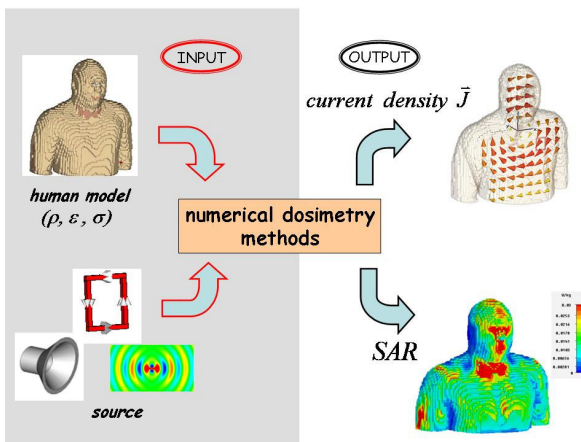

General approach of numerical dosimetry

There are several different calculation methods, many of which are described in the CENELEC standards, e.g. EN 50392: 2004 - *Generic standard to demonstrate the compliance of electronic and electrical apparatus with the basis restrictions related to human exposure to electromagnetic fields (0 Hz – 300 GHz)*:

- boundary element method (BEM);
- finite difference frequency domain (FDFD);
- finite difference time domain (FDTD);
- finite element method (FEM);
- finite integration technique (FIT),
- method of moments (MoM).

How can numerical methods be implemented?

Many of numerical methods are implemented on commercial SW packages, mostly developed by research teams, provided with anatomical human body models and CAD tools able to represent sources and environment.

The best choice of the computational method suitable to the case on study depends on several factors, mainly the frequency of interest and the exposure condition (near or far field). Other factors to be taken into account are the geometrical characteristics of exposure scenario, and the computational time that is related to the method and to the memory present on hardware resources available.

Computational time is also related to the resolution of the anatomical model (voxel dimension).

How are human body models obtained?

Human body models are based on CAT (Computerized Axial Tomography) and MRI (Magnetic Resonance Imaging) medical data, processed in order to recognize different types of tissues.

Dielectric properties (that are strongly frequency dependent) are assigned according to scientific data based on direct experimental evaluation or fitting of experimental results.

Once the exposed subject has been segmented, values for conductivity σ and relative permittivity ϵ have to be assigned. This is usually accomplished through preliminary assessment of the type of tissue of each segment, and subsequent application of a parametric model able to represent the dielectric properties of biological tissues in the frequency range from 10 Hz to 100 GHz.

Internet applications are currently available and allow to professionals the on-line calculation and download of the values of dielectric properties of about fifty different human tissues in the above frequency range. In particular:

- the web page of the Federal Communications Commission (USA): "Tissue Dielectric Properties", <http://www.fcc.gov/cgi-bin/dielec.sh>;
- the web page of the Institute for Applied Physics "Nello Carrara" (IFAC) of the Italian National Research Council (CNR): "Dielectric Properties of Body Tissues", <http://niremf.ifac.cnr.it/tissprop/>.

An alternative approach is aimed at directly determine the dielectric properties of each voxel, bypassing the tissue recognition process. This approach is based on the evaluation of the tissue water content by means of automatic processing of the MRI images. Its applicability is limited to frequencies above 100 MHz and the information on tissue type is not available.

The most common examples of body model are the MEET Man and HUGO, based on data from the Visible Human Project (VHP) of the National Library of Medicine, Bethesda, Maryland, USA. Such models are categorized into 40 different types of tissue.

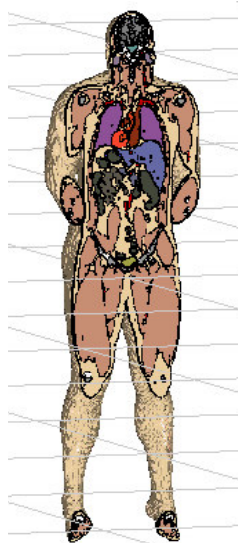

Example of VHP model, coronal section view showing different organs and tissues

Norman (NORmalized MAN) is another useful dataset based on medical imaging data, where 37 different tissues are recognized, scaled to match with the ICRP Standard Man.

The International Commission for Radiological Protection (ICRP) has defined a "Standard Man" who is 1.76 m tall with a mass of 73 kg. The reference adult female is 1.63 m tall with a mass of 60 kg.

Anatomical models are commonly scaled to Standard Man, and should fulfil the following requirements:

- representative of human shape;
- representative of the inhomogeneous structure of the human body;
- realistic dielectric properties of tissues;
- data resolution better than or equal to 10 mm steps.

Some available examples are mentioned.

The **Visible Man** data set is the first result of the Visible Human Project of the National Library of Medicine, Bethesda, Maryland, USA. It is a complete digital image data set of a human male, and it consists of CAT and MRI scans as well as criosection images.

The **"MEET Man"**, developed at the Institute of Biomedical Engineering, University of Karlsruhe Germany, is a processed version of the Visible Man data set which has been segmented and classified into 40 different tissue types.

"Hugo", from ViewTec, Zürich, Switzerland, is an anatomical 3D volume and surface data set, based on Visible Man information. Data are categorised into 40 types of tissue.

"NORMAN" model, developed at the National Radiological Protection Board (NRPB) UK, is a 3D array of voxels, each of which contains information on discrete tissue type. It is based on medical imaging data and has been categorised into 37 different tissue types and scaled to match the standard man.

"NAOMI" (aNAtOMIcal model), was designed at NRPB to be representative of an adult female. It has 41 tissues types, and is based on high-resolution MRI scan of a female subject, rescaled to ICRP standard reference.

The model from **University of Utah**, USA, was obtained from MRI scans of a male volunteer. It is categorised into 31 tissue types and is scaled to match the standard man.

The model from **University of Victoria**, Canada, is a voxel-based model, categorised with up to 128 different tissues.

The **Zubal phantom**, from Yale University, New Haven, USA, is based on the segmentation of CAT head and trunk, and MRI head slices of two living human males. Each voxel is designated as belonging to a given organ or internal structure; 68 index numbers are assigned.

Can simplified human body models be used?

In some cases numerical evaluation can be performed by means of simple homogeneous body models, like sphere or prolate spheroid. The dielectric properties can be assigned according to the whole body average at the frequency of interest, or be representative of a particular tissue.

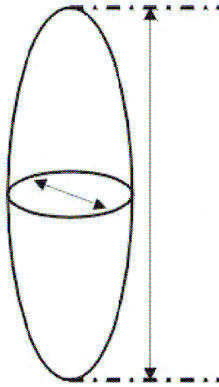

Example of numerical model of an homogenous ellipsoid, from CENELEC standard EN 50392

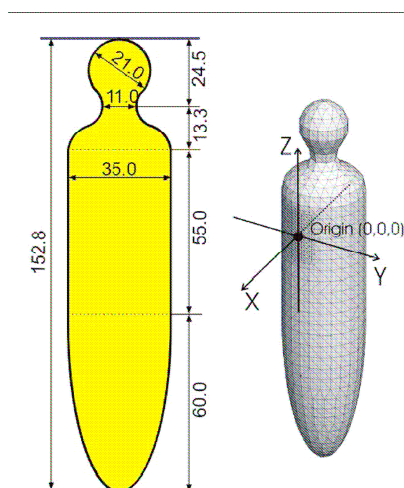

Example of numerical model of an homogenous human body, from CENELEC standard EN 50392

How can SAR evaluation be performed in the high frequency range?

Most of the available methods implemented on commercial software packages concerns high frequency range, and in the latest years a great effort was addressed to apply numerical methods to the case of mobile phones (head exposure), as well to base stations and broadcasting (whole body exposure).

Numerical methods commonly adopted are:

- multipole technique (MMP);
- finite difference in time domain (FDTD);
- finite element method (FEM);
- finite integration technique (FIT);

- method of moments (MoM);
- hybrid technique.

FDTD is considered to be the most suitable SAR calculation technique, even though very powerful computers are needed for accurate calculation purposes, and several commercial packages are available.

In appendix 1 some examples of commercial software are listed, with their main characteristics. Costs may range approximately from few to several tens of thousands Euro, also depending on the features implemented and on the legal nature of the buyer (scientific institutions commonly take advantage of discounts).

In Appendix 2 an example is shown of implementation of FDTD method in the case of exposure to RF fields emitted by a radio frequency antenna.

How can induced current density evaluation be performed in the low frequency range?

Several computational methods are employed in the low frequency range, such as:

- method of moments (MoM);
- impedance network method;
- scalar potential finite difference method (SPFD);
- the current vector potential (CVP) (usually limited to two dimensional problems);
- finite element method (FEM).

Low frequency applications take advantage of quasi-static approximation (QSA). QSA approach is applicable when the linear dimensions of the involved objects and their mutual distances are small relative to the wavelength. In this case the effect of propagation of the fields inside the body can be considered negligible, and the electric and magnetic field problems can be solved separately, using the methods of electrostatics and magnetostatics. QSA should be applied up to few hundreds of kHz.

Among the available numerical methods for quasi-static applications, the SPFD approach appears to be the most suitable to study complex 3D problems, like those met in occupational exposures.

Some commercial packages implement typical high frequency methods, and adopt a *frequency scaling method*, to solve Maxwell's equations at RF range ($f \leq 0.5$ MHz) and scale results at lower frequencies. The number of software packages commercially available dedicated to low frequencies is however to date very limited, as

they are mostly employed for specific research purposes (see again Appendix 1).

In appendix 3 an example of application in the low frequency range is reported.

Are technical standards concerning dosimetry available?

Several standards dealing with dosimetry have been issued by CENELEC and by the International Electrotechnical Commission (IEC). Most of them are addressed to the emission of specific products (e.g. EAS devices or mobile phones) in order to verify the compliance with Council Recommendation 1999/519/EC.

The most standards deals with experimental dosimetry and indicates accurate procedures to measure dosimetric quantities.

Some of current CENELEC standards dealing with numerical dosimetry are EN 50357, EN 50364, EN 50392, EN 50366/A1, EN 62226-2-1, EN 50383, see references.

Application to occupational exposure has not been carried out yet, and CENELEC started working at this aim after the publication of Directive 2004/40/EC, under the specific mandate M/351.

Accuracy of numerical dosimetry in occupational exposure assessment

Despite the possibility to represent complex exposure problems, dosimetric computational results are affected by some intrinsic limitations.

A basic factor of uncertainty is the lack of detailed knowledge of dielectric properties of human tissues at the lowest frequencies.

Moreover, other than *in situ* field measurements, any numerical result actually refers to the representation of the exposure scenario, and not to the real problem. To get accurate results on real situations, very high resolution models of human body for different ages, dimensions and phenotypes should be implemented.

Such models should also be able to represent typical occupational complex postures, as the available ones refer to the posture of the body during MRI or CAT scan.

Methods have been introduced for processing anatomical models in order to get different body postures.

Some of such methods are implemented on commercial packages, but the accuracy of results need to be carefully validated in a wide number of conditions. Many research centres are working at the problem and good results are expected in the next years.

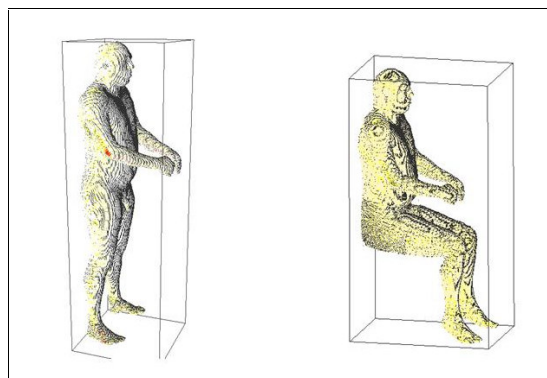

*Example of articulation of human model.
(From Andreuccetti and Zoppetti, 2007)*

Other problems affecting the accuracy of results are related to the numerical modelling of the EMF source. The information on the operation of the source of exposure can be poor in terms of physical or geometrical characteristics. For instance, modern welding machines have digitally controlled power electronic circuits that produce complicated current pulses, very difficult to be detected with common measurements. As other example, mobile phone base station antennas are inside weather proof welded plastic casing, that cannot be opened for visual inspection to observe the structure and type of radiating parts.

Such kind of information is often not easily available from the manufacturer and, in worst cases, even regarded as a trade secret. In these cases it is important to be able to assemble a model of the exposure scenario that safely overestimates the exposure, which requires good understanding of the physics and the technology used in the device. The role of the manufacturers of equipment could be however more active in this area.

It should also be remarked that the methods implemented in commercial packages are not fully standardized or validated each other, especially in the low frequency range. At the same time, the algorithms used to obtain dosimetric quantities from raw EM results (e.g. internal electric field) are not harmonized, and sometimes they are not even knowable by the user of the package.

At the state of art, a detailed knowledge for the evaluation of uncertainty in numerical dosimetry has not entirely been achieved, and the accuracy of results can be very poor, especially for complex exposure scenarios.

How to deal with uncertainty?

Uncertainty always affects the results of measurements and numerical calculations, and plays an important role in risk assessment.

In the European Directive 2004/40/EC the problem on how to deal with uncertainties in the compliance judgment is not discussed. At the moment only standards applicable to emission of specific products give practical advice on how to treat uncertainty. Few standards require the uncertainty to be quantitatively included in the comparison with the limit of exposure (e.g. EN 50366).

The prevailing indication is however that uncertainty must be assessed and reported, but measurements or calculation results shall be directly compared with the limits, provided that the uncertainty is lower than a recommended value (*shared uncertainty budget approach*).

Typical permissible uncertainties defined in relevant CENELEC standards range from ± 3 dB (+41 %, -30 %) up to ± 6 dB (+100 %, -50 %) for field measurements, and are of the order of ± 50 % for numerical calculation.

The shared uncertainty budget approach, like explained in CENELEC standard EN 50364, implies that the measured or calculated values shall be used for comparison with exposure guidelines, provided that the total uncertainty is less than or equal to permissible or reasonable pre-defined values, or if the assessment is proven to always overestimate the exposure. Uncertainty shall be always assessed and reported, but results shall be directly compared with the limits.

There's however a deep difference between product and exposure standards. From the philosophical point of view, the shared risk approach could be applicable when the end user, or the authority responsible for control, makes a judgement of compliance and takes some of the risk that the product may not meet the specification. Such approach is reliable for product emissions, but in the case of exposure risk assessment the adoption of too large permissible uncertainties could in fact relax the limits of exposure and reduce level of protection.

In which situations there is a need for numerical dosimetry in occupational exposure assessment?

The provisions deriving from directive 2004/40/EC imply the necessity to identify the situations when numerical calculations in EMF occupational risk assessment are required.

A general need for computational EMF exposure assessment occurs when action values established by the directive are exceeded and no mitigation measure is possible. Such a case may occur in the case of RF fields strictly confined close to the source, similarly to head exposure from a mobile phone. Numerical calculations represent a useful

tools for analysing near-field conditions, taking into account the inhomogeneity of the exposure and the influence of parameter variations (e.g. distance from the source, part of body exposed, etc.).

A second case deals with compliance with local basic restrictions. Guidelines of ICNIRP states that: *"the reference levels are intended to be spatially averaged values over the entire body of the exposed individual, but with the important proviso that the basic restrictions on localized exposure are not exceeded"*.

In other words, reference levels (action levels in the EU directive) are able to guarantee compliance with whole body averaged SAR, but they don't assure compliance with restrictions on local SAR, which is however crucial when the source is very close to the worker and directly coupled to the body.

In the frequency range 10 MHz - 110 MHz, where the electromagnetic energy is mostly absorbed inside limbs, ICNIRP Guidelines and EU directive provide a reference/action level for limbs current that is helpful in order to verify compliance with local SAR limits in the limbs.

On the other hand, in the "hot spot" frequency range (400 MHz - 3 GHz) localized peaks of energy absorption may concern internal organs, even in condition of respect of whole body SAR limit. In such situation, according to the criteria given by Jokela (Jokela, 2007), the assessment of local SAR by means of numerical calculation should be recommended even in a condition where body averaged reference levels are not exceeded, in the case that, considering the exposure level in terms of power density, the peak-to-average ratio over the body is more than 6 dB (a factor of 2 in terms of fields values).

It must be finally remarked that numerical calculation will be required in product standardization of some work equipment (or families of equipment) able to generate electromagnetic fields, in order to automatically guarantee their compliance with the EU directive before they are put into the market, like it currently happens for mobile phones and other devices referred to EU recommendation of July 1999.

In this frame CENELEC is working at product standards on welding equipment (arc, resistance and allied processes).

Is today numerical dosimetry practically applicable in occupational exposure assessment?

As a matter of fact, the application of numerical methods to occupational exposure assessment is a very complicated task requiring high skilled expertise, to-date available only in research centres or institutes.

For technical and economical reasons, the possibility of practical use of numerical modelling by employers in real work environment seems to be very limited at the moment, especially for small and medium enterprises.

On the other side, numerical techniques could have effective use for large scale manufacturing in standard and traceable condition.

What is the information for policy makers?

While the fundamental aspects of EM numerical dosimetry methods have been widely investigated in the latest decades, it must be recognized that currently available software packages are still at a research stage. Commercial products are too “general purpose” tools, expensive, and probably too complex to be used by standard occupational safety technicians, not being specifically designed for their routine tasks.

In the aim of creating an effective system able to promote safety from electromagnetic fields at work, there is the opportunity for a twofold development action: a short/medium term and a long term action.

Short/medium term action

In the short term, there is the need to create practical tools, able to make risk assessment on EMF (including numerical calculation) a feasible

and sustainable process even by small employers and enterprises.

Cooperation among employers and their associations with academic and research institutions should be promoted and supported at financial level by authorities and governments.

In this frame research institutions could provide dosimetric calculations for situations of general interest. All information and results on specific sources of exposure should be gathered in special data-bases, to be made accessible to employers, safety technicians, institutions on safety at work and control authorities.

This network should allow small employers to produce reliable risk assessments at reasonable costs.

Long term action

Academic and research institutions, including private software companies, should develop software applications specifically designed for assessing compliance with limit values in occupational exposures to EMF.

This activity should be performed in cooperation with national institutions on occupational safety and health, which will have the role of establishing general specifications and usability requirements.

This activity should also have the result of stimulating and driving private software companies to implement specific software packages, giving rise to a competition which will lead to better products at lower prices.

Appendix 1: Examples and characteristics of commercial software

Antennessa® (<http://www.antennessa.com>)

(Plouzané – FRANCE)

- *Frequency range:* RF, MW
- *EMF Visual* tool is a 3D prediction and modelling software for the assessment of human exposure to electromagnetic field in a real environment
- *Facilities:* analysis of the EM fields emitted by the base station antennas
- *Anatomical models:* TWIN Specific Anthropomorphic Mannequin (SAM) phantom, upright phantom, Custom flat phantom
- *Output:* SAR calculation

CST EM STUDIO® (<http://www.cst.com>)

(Darmstadt – GERMANY)

- *Frequency range:* low frequencies (ELF, LF)
- based on the Finite Integration Technique (FIT)
- *Facilities:* connectors, transmission lines, filters, antennas
- *Anatomical models:* compatible with voxel models
- *Output:* electric fields, magnetic fields, surface currents, current densities

CST MicroWave STUDIO® (<http://www.cst.com>)

(Darmstadt – GERMANY)

- *Frequency range:* high frequencies (RF, MW)
- based on the Finite Integration Technique (FIT)
- *Facilities:* connectors, transmission lines, filters, antennas
- *Anatomical models:* database Hugo 3D, Specific Anthropomorphic Mannequin (SAM) phantom
- *Output:* electric fields, magnetic fields, surface currents, power flows, current densities, power loss densities, electric energy densities, magnetic energy densities

CST Micro-Stripes® (<http://www.microstripes.com>)

(Darmstadt – GERMANY)

- *Frequency range:* RF, MW
- 3D simulation software which employs the time domain TLM (Transmission line Matrix) method
- *Facilities:* microwave and RF devices, antennas, connectors, high frequency IC's
- *Anatomical models:* standard Specific Anthropomorphic Mannequin (SAM) phantom test head, Biological Tissue Library
- *Output:* 1g and 10 g averaged SAR

EMPIRE® (<http://www.empire.de/>)

(Kamp-Lintfort – GERMANY)

- *Frequency range:* 50 Hz – 300 GHz
- 3D electromagnetic field simulator based on the 3D Finite Difference Time Domain Method (FDTD)
- *Facilities:* planar structures, interconnects, multi-port multilayer packages, waveguides, antennas and EMC problems
- *Anatomical models:* human body model standing/sitting position with 42 tissues, human head model, animal model (rat, goat, monkey), Specific Anthropomorphic Mannequin (SAM) phantom
- *Output:* SAR and ACD calculation with averaging, current density calculation

FEKO® (<http://www.feko.info>)

(Stellenbosch - SOUTH AFRICA)

- *Frequency range:* RF, MW
- full wave, method of moments (MoM) based, Finite Difference Time Domain (FDTD), Finite Element Method (FEM), hybrid MoM/FEM
- *Facilities:* EMC, shielding, coupling, antenna design, antenna placement analysis, microstrip antennas, and circuits, striplines, dielectric media, scattering analysis
- *Anatomical models:* Visible Human Full Model, Visible Human head and shoulders, Anthropomorphic Mannequin (SAM)
- *Output:* WinFEKO has a special module for the calculation of the SAR according to the specifications of regulating bodies

Maxwell® 3D ANSOFT (<http://www.ansoft.com/>)

(Pennsylvania – USA)

- *Frequency range:* RF, MW
- Finite Element Method (FEM)
- *Facilities:* electromechanical components, high-power MRI coils, motors, actuators, transformers and other electric and electromechanical devices.
- *Output:* field visualization and animation, current, induced voltage, power loss, stored energy, hysteresis loss

Remcom XFDTD® (<http://www.remcom.com>)

(Pennsylvania - USA / West Midlands - ENGLAND)

- *Frequency range:* RF, MW
- Full-Wave Three-Dimensional EM Solver - Finite Difference Time Domain (FDTD) method
- *Facilities:* antennas, microwave circuits, bio-EM, EMC, scattering, photonics
- *Anatomical models:* VariPose for repositioning of the Male Visible Human mesh including internal anatomical structures.
- *Output:* Bio-EM Capabilities (Male and Female Human Body Meshes, SAR with 1 g and 10 g averages, whole body average, locate peak SAR, SAM Head for SAR, partial volume SAR)

SEMCAD 3-D® (<http://www.semcad.com>)

(Zurich – SWITZERLAND)

- *Frequency range:* RF, MW
- Based on the Finite-Difference Time-Domain (FDTD) method
- *Facilities:* simulation platform for EMC, antenna design and dosimetry
- *Anatomical models:* more than 5 full body anatomical human phantoms (HUGOs, Virtual Family, etc.), more than 10 small animal models (rat, mouse, young, adult, male, female, pregnant, etc.), Specific Anthropomorphic Mannequin (SAM)
- *Output:* SAR distribution, spatial peak SAR, peak SAR averaged in 1g and 10 g, standard deviation, total absorbed power, mass of lossy materials

Zeland Software® (<http://www.zeland.com/>)

(California – USA)

- *Frequency range:* RF, MW
- FDTD, MoM
- *Facilities:* microwave circuits, components and antenna, wireless/RF antennas, EMC and EMI structures, and other high-speed and high-frequency circuitry.
- *Output:* complete SAR-calculation and display; users can control the input power level and can access the parameters such as absorbed power and radiated power.

Appendix 2: Example of SAR calculation for exposure to near field generated by a radio-base station antenna

Radio-base station antennas (RBA) are used in communication to send and receive signals to and from mobile phones. RBA are usually placed on top of buildings or towers, working at transmission powers relatively low, typically less than 40 W.

RBA use highly directional radiators that transmit in the forward direction; occupational exposure is possible during tasks in the vicinity of the antennas, such as construction or maintenance.

In order to evaluate workers' exposure to EM radiation, the energy absorbed by human tissues can be calculated by means of numerical approach. Several issues, such as the shape of the human body, the tissue characterization, the frequency and geometry of EM source, need to be taken into account.

In the example, SAR calculation due to exposure in the near field of a commercial antenna operating at the frequency of 900 MHz and emitted power of 32 W is reported.

The geometrical characteristics of the antenna are in the following picture.

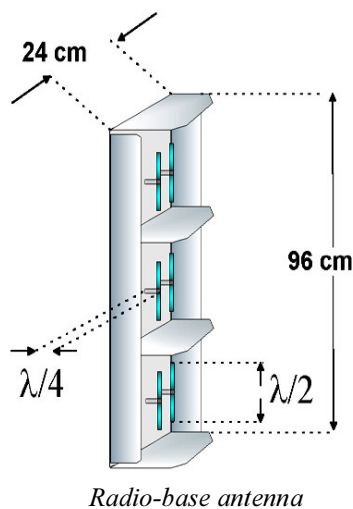

Calculation is based on the finite-difference time-domain (FDTD) method, in a full-wave approach.

SAR results have been obtained on the Zubal human model, that is limited to head and trunk. Calculation has been performed at several distances model-antenna. The local SAR has been evaluated as averaged both over 1 g of tissue (1-g SAR) and over 10 g of tissue (10-g SAR).

Considering a 30 cm model-antenna distance, the resulting average SAR in the head is 0.44 W/kg, while the average SAR in the trunk is 0.05 W/kg. Results on local SARs are displayed in the

following picture. Local SAR in the head exceeds the corresponding ICNIRP occupational limit, given as 10 W/kg as 10-g averaged SAR.

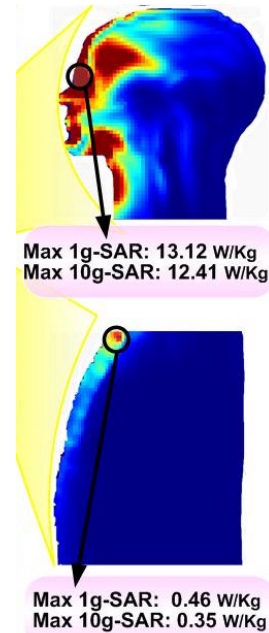

Maximum SAR values in the head and trunk regions.
The model-antenna distance is 30 cm.

As further step, local SAR in the head has been calculated on a homogeneous model, obtained from the Zubal phantom assuming a uniform inner structure with constant dielectric properties. The results, compared with heterogeneous model, are represented in the next picture.

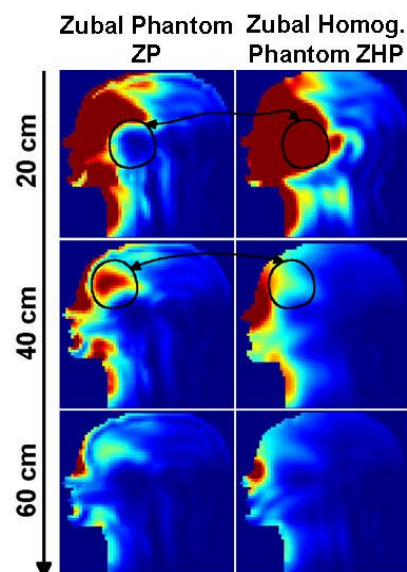

SAR (1-g) values for heterogeneous and homogeneous Zubal models. At closer distances from the source, the SAR pattern inside the head may significantly differ in the two cases.

As final step, SAR results have been obtained using the Visible Human Project (VHP) model, and a homogeneous model obtained from the WHP assuming constant dielectric properties.

The next table summarizes the result obtained with all human models.

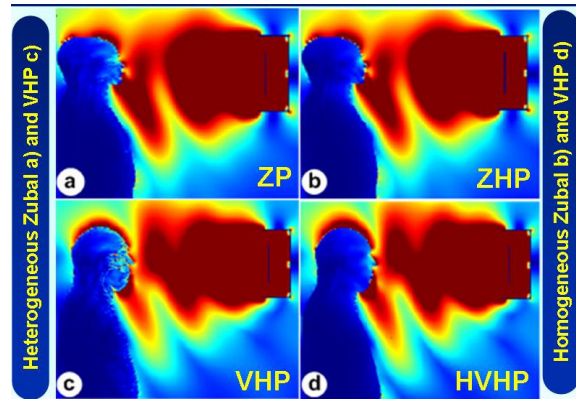

E-field levels at 60 cm distance from the antenna for heterogeneous and homogeneous models

Peak SAR values in head and trunk for the Zubal and the VHP models, varying the model-antenna distance

1-g SAR and 10-g SAR peak values [W/kg]					
Distance	Type	Zubal heterogeneous	Zubal homogeneous	VHP heterogeneous	VHP homogeneous
20 cm	1 g	30.3	29.5	18.4	25.7
	10 g	15.3	16.6	11.97	17.2
30 cm	1 g	12.6	11.7	13.4	17.8
	10 g	6.3	6.6	8.6	12.0
40 cm	1 g	10.7	10.0	6.1	9.2
	10 g	5.3	5.6	4.1	6.5
50 cm	1 g	5.3	4.9	4.8	6.8
	10 g	2.6	2.7	3.1	4.8

A detailed analysis of peak SAR values obtained with different human models is summarized into the following points:

- when comparing the two heterogeneous models, differences of up to 40% are observed;
- when comparing one of the heterogeneous models with its homogeneous companion, the difference is up to 50 %;
- when comparing homogeneous models with similar dielectric characterization but different shape, the maximum difference is up to 50%;

- when comparing homogeneous phantoms with the same shape but different dielectric characterization (up to 30% for permittivity and 13% for the conductivity) the differences are up to 10%.

Whichever the human model (and likely the method) employed, the possibility of a high degree of imprecision should be carefully taken into account in the interpretation of calculation results, during the process of risk assessment.

Appendix 3: Example of calculation of induced current due to exposure to magnetic field from an induction heater.

Induction heaters are used for industrial treatment of metals and semiconductors, in processes such as welding, melting and hardening.

The elements under treatment (e.g. two parts of a pipe to be welded) are usually inserted inside solenoid applicators, supplying energy to the material by induction of eddy currents. The strong current implies the presence of intense magnetic field in the environment around the applicator.

The example refers to an equipment used to melt gold for production of jewellery. The operating frequency is 3450 Hz. Calculation of induced current density J is made using the SPFD method. The field source is a copper solenoid, represented

as a cylinder of radius 0.09 m and height 0.2 m, made of 14 coils. In the calculation domain the position of the coil is chosen in order to obtain the best fit between the magnetic field values calculated by the numerical model, and experimental measurements around the real coil. The top of the fingers of the human model is less than 10 cm distant from the conductor (see the following picture).

The value of current in the coil is 400 A (rms value), according to real data. The reference voxel phantom used for calculation is the VHP (Visible Human Project) model of the entire body at the resolution of 3 mm.

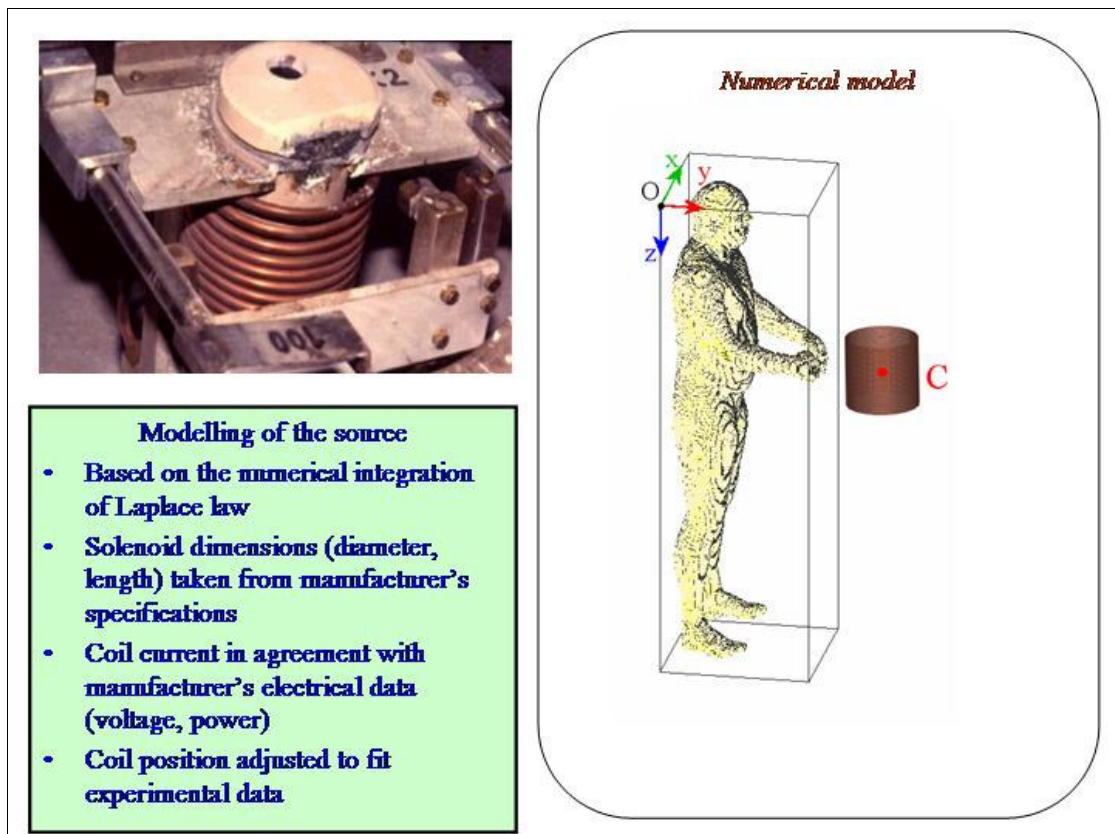

Representation of human model and source

The distribution of current density inside the body is well displayed by a thematic map where different colours are associated to different values of current. In order to give information about organs and tissues, thematic map may be referred to coronal, sagittal and axial section of the body.

The following picture shows an example of thematic maps referred to coronal and axial sections. The maps allow the identification of areas where current density is exceeding the exposure limit value.

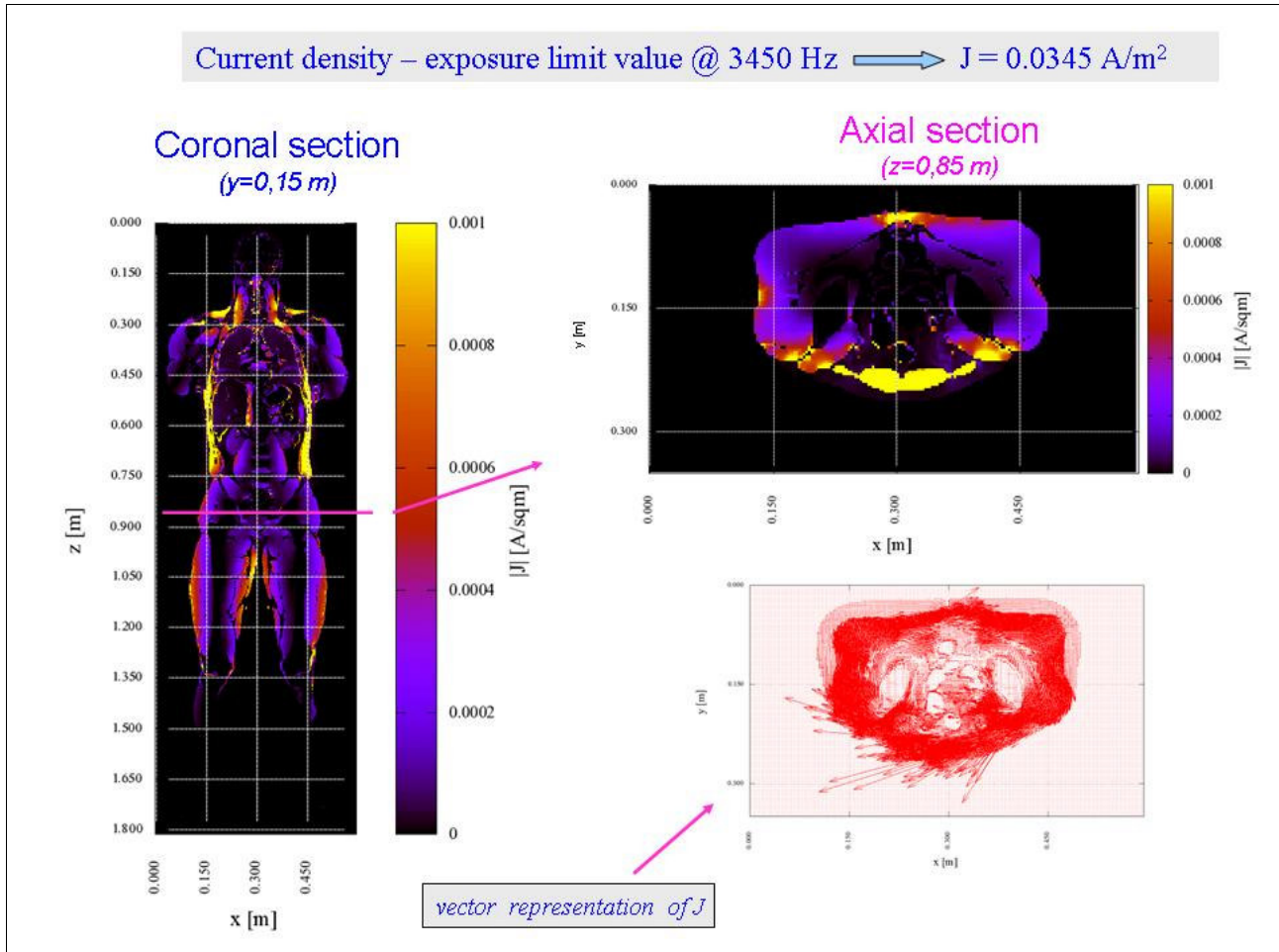

*Thematic map of current density, in coronal and axial view.
Yellow indicates the areas where exposure limit value is exceeded*

Results of calculation show a non uniform distribution of current density. The table reports organs and tissues where the exposure limit value, at the given frequency, from directive 2004/40/EC is exceeded.

Parts of the body where the exposure limit value of 34.5 mA/m^2 (at 3450 Hz) is exceeded	
Organs and tissues	$ J $ [mA/m ²]
Bladder	40
Hands (cartilage)	111
Hands (bone)	95
Cerebrospinal fluid	113
Colon	108
Arms (muscle)	235
Pancreas	51
Small intestine	202
Gall bladder	142
Stomach	95

References

CENELEC EN 50357: 2001 - Evaluation of human exposure to electromagnetic fields from devices used in Electronic Article Surveillance (EAS), Radio Frequency Identification (RFID) and similar applications.

CENELEC EN 50360: 2001 - Product standard to demonstrate the compliance of mobile phones with the basic restrictions related to human exposure to electromagnetic fields (300 MHz - 3 GHz).

CENELEC EN 50364: 2001 - Limitation of human exposure to electromagnetic fields from devices operating in the frequency range 0 Hz to 10 GHz, used in Electronic Article Surveillance (EAS), Radio Frequency Identification (RFID) and similar applications.

CENELEC EN 50383: 2002 - Basic standard for the calculation and measurement of electromagnetic field strength and SAR related to human exposure from radio base stations and fixed terminal stations for wireless telecommunication systems (110 MHz - 40 GHz).

CENELEC EN 50384: 2002 - Product standard to demonstrate the compliance of radio base stations and fixed terminal stations for wireless telecommunication systems with the basic restrictions or the reference levels related to human exposure to radio frequency electromagnetic fields (110 MHz - 40 GHz) – Occupational.

CENELEC EN 50385: 2002 -Product standard to demonstrate the compliance of radio base stations and fixed terminal stations for wireless telecommunication systems with the basic restrictions or the reference levels related to human exposure to radio frequency electromagnetic fields (110 MHz - 40 GHz) - General public.

CENELEC EN 50366: 2003 - Household and similar electrical appliances - Electromagnetic fields - Methods for evaluation and measurement.

CENELEC EN 50392: 2004 - Generic standard to demonstrate the compliance of electronic and electrical apparatus with the basic restrictions related to human exposure to electromagnetic fields (0 Hz – 300 GHz).

CENELEC EN 62226-2-1: 2005 - Exposure to electric or magnetic fields in the low and intermediate frequency range - Methods for calculating the current density and internal electric field induced in the human body. Part 2-1: Exposure to magnetic fields - 2D models

CENELEC EN 50366/A1: 2006 - Household and similar electrical appliances - Electromagnetic fields - Methods for evaluation and measurement.

Directive 2004/40/EC of the European Parliament and of the Council on the minimum health and safety requirements regarding the exposure of workers to the risks arising from physical agents (electromagnetic fields). www.europa.eu.int/eur-lex/en/

ICNIRP Guidelines for Limiting Exposure to Time-Varying Electric, Magnetic, and Electromagnetic Fields (up to 300 GHz), Health Physics, vol. 74, No. 4 (April), 494-522, 1998.

Jokela K: Assessment of complex EMF exposure situations including inhomogeneous field distribution. Health Physics 92(6):531-40; 2007

Recommendation of the European Council 1999/519/CE of 12 July 1999 on the limitation of exposure of the general public to electromagnetic fields (0 Hz to 300 GHz).

An information publication from the EMF NET project

Authors: Rosaria Falsaperla and Paolo Rossi, with participation of Gian Marco Contessa.
National Institute for Occupational Safety and Prevention (ISPESL), Occupational Hygiene
Dept., Rome, Italy.

Phone +39 06 94181440 • **http://web.jrc.ec.europa.eu/emf-net/**

Examples in Appendixes 2 ad 3 are taken, with permission of authors, from:

Luca Catarinucci and Luciano Tarricone: High Performance FDTD for Human-Antenna Interaction Problems in the Near Field, International Workshop on Electromagnetic Fields in the Workplace, Warszawa (Poland), September 5th-7th 2005.

Daniele Andreuccetti and Nicola Zoppetti: Occupational exposure to quasi-static electromagnetic fields and the EU 2004/40 Directive: assessment of induced current densities in realistic scenarios using a 3D dosimetric approach based on the scalar potential finite difference numerical technique and a posturable digital body model, XIV Congress of the Polish Radiation Research Society, Kielce (Poland), September 24th-26th 2007.